

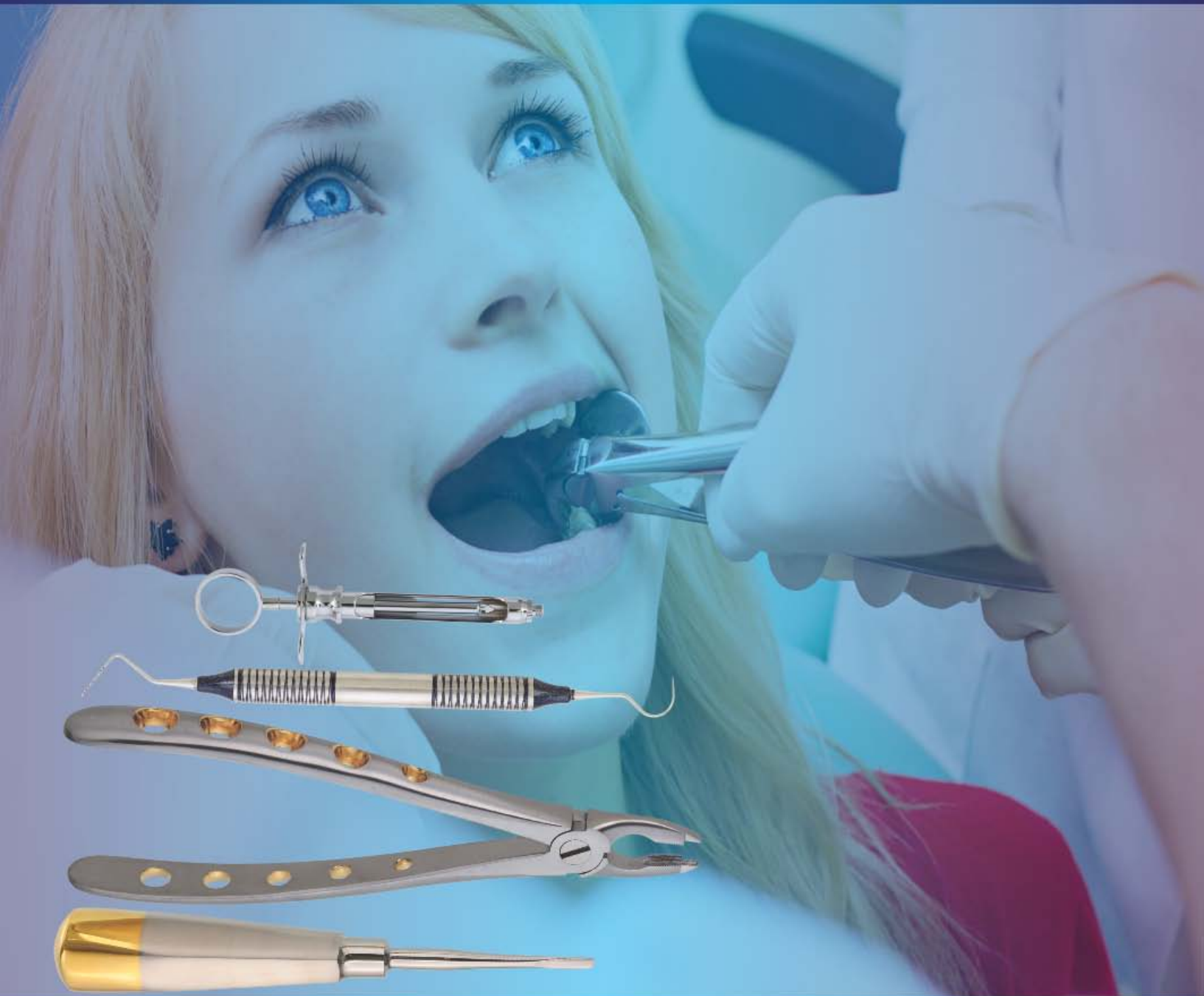

LUMINES INTERNATIONAL

Manufacturers & Exporters of Dental Instruments.



DENTAL INSTRUMENTS CATALOGUE



Dear Valued Buyers

We feel immense pleasure to present our latest catalogue in which we have featured a most comprehensive range of all types of quality Surgical & Dental instruments required for day to day use for Hospital & Dentist. We will be pleased to quote you a competitive Price and Delivery time.

All instruments are manufactured according to the recognized standard patterns currently in use in Hospital throughout the world and are being produced under restrict control of experts to avoid any flaw and to refrain any complaint at any stage.

A group of very vast experienced persons in manufacturing handling our quality Control System.

Any instruments proven defective in workmanship or material will be replaced with out charges.

We express our thanks to all our customers for the confidence they have placed us in the past. We further assure them that we will continue our best efforts to gain their confidence in the future.

We are always at your service.

Chief Executive

LUMINES INTERNATIONAL



01

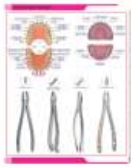

EXTRACTING FORCEPS

Page # 01 - 14H

02



ROOT ELEVATORS

Page # 15 - 29

03



DIAGNOSTIC, PROBES, SCALERS, FILLING & LABORATORY INSTRUMENTS

Page # 30 - 77

04



MAXILLOFACIAL SURGERY INSTRUMENTS

Page # 78 - 95

05



ORTHODONTIC INSTRUMENTS & PLIERS

Page # 96 - 107

06



DENTAL IMPLANT INSTRUMENTS

Page # 108 - 142

07

impression Tray & Hollow wares

Page # 143 - 151



Handle Selection For Extracting Forceps

Dear Valued Buyers if any Universal Fig. No. of Extracting Forceps not Found in our Catalogue you Can Refer the Fig. No. From These Diagram.

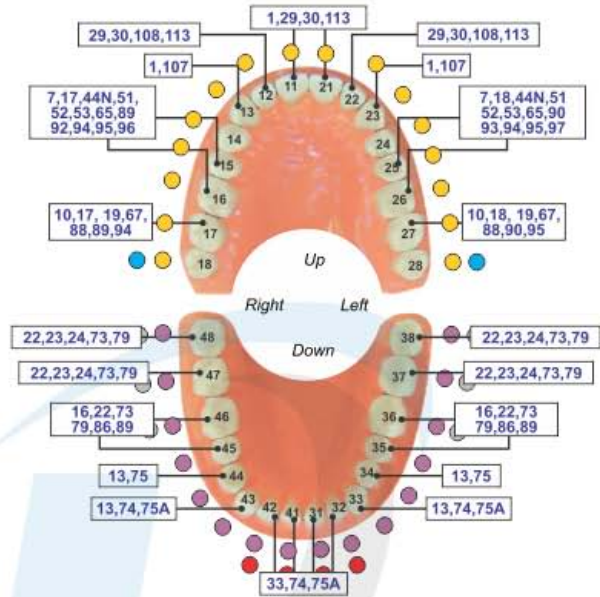
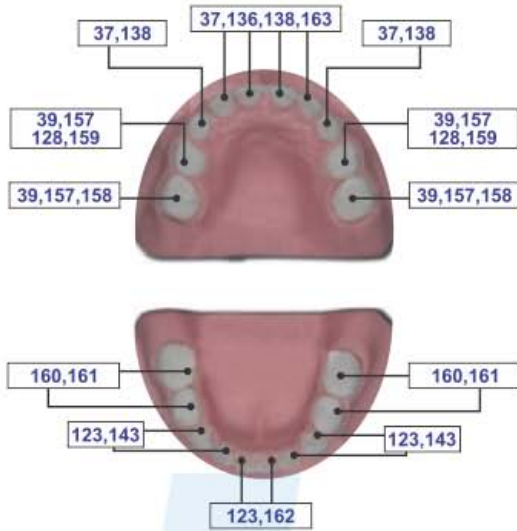

Dear Valued Buyers these are our Handle Styles



English Pattern



English Pattern



English Pattern, Anatomical Handle



American Pattern



Deep Grip Forceps With Hole Pattern



Hole Pattern



A



B



C



D



E



F





EXTRACTING FORCEPS (English Pattern)

- Щипцы экстракционные (английская форма)
- Daviers (Forme Anglaise)
- Zahnzangen (Englische Form)

- Щипці екстракційні (англійська форма)
- Forceps de Extracción (Forme Inglesa)
- استخراج الملقط (نمط اللغة الإنجليزية)



DE-001
Fig. 1
Upper Centrals
and Canines



DE-002
Fig. 2
Upper Laterals
and Canines



DE-003
Fig. 4
Lower Incisors
and Canines



DE-004
Fig. 7
Upper Premolars



DE-005
Fig. 8
Lower Premolars



DE-006
Fig. 13
Lower Premolars



DE-007
Fig. 17
Upper Molars,
Right



DE-008
Fig. 18
Upper Molars,
Left



DE-009
Fig. 21
Lower Molar



DE-010
Fig. 22
Lower Molar

EXTRACTING FORCEPS (English Pattern)

- Щипцы экстракционные (английская форма)
- Daviers (Forme Anglaise)
- Zahnzangen (Englische Form)
- Щипці екстракційні (англійська форма)
- Forceps de Extracción (Forme Inglesa)
- استخراج الملقط (نمط اللغة الإنجليزية)



DE-011
18A
upper molars



DE-012
19
upper third molars



DE-013
20
lower third molar



DE-014
24
lower molar, right



DE-015
29
upper roots



DE-016
30
Upper Roots



DE-017
33
lower roots



DE-018
33A
Lower Roots



DE-019
33M
Lower roots
with long beak



DE-020
46L



DE-021
51
Upper Roots



DE-022
51A
Upper Roots





EXTRACTING FORCEPS (English Pattern)

- Щипцы экстракционные (английская форма)
- Daviers (Forme Anglaise)
- Zahnzangen (Englische Form)

- Щипці екстракційні (англійська форма)
- Forceps de Extracción (Forme Inglesa)
- استخراج الملقط (نمط اللغة الإنجليزية)

WISDOM EXTRACTING FORCEPS



DE-023
Routurier
(# 22 ½ L)
lower molars and
wisdoms, left



DE-024
Routurier
(# 22 ½ R)
lower molars and
wisdoms, right



DE-025
Routurier
(# 33 ½ L)
lower molar and
wisdom roots, left



DE-026
Routurier
(# 33 ½ R)
lower molar and
wisdom roots, right



DE-027
Fig. 186L
lower molars



DE-028
Fig. 186R
lower molars



DE-029
51AL



DE-030
67
Upper Thrid Molars



DE-031
67A
Upper Thrid Molars



DE-032
79
Lower Third Molars



EXTRACTING FORCEPS (English Pattern)



- Щипцы экстракционные (английская форма)
- Daviers (Forme Anglaise)
- Zahnzangen (Englische Form)
- Щипці екстракційні (англійська форма)
- Forceps de Extracción (Forme Inglesa)
- استخراج الملقط (نمط اللغة الإنجليزية)



DE-033
73
Lower Molars

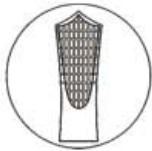

DE-034
73 A
lower molars



DE-035
73 S



DE-036
74
Lower Roots



DE-037
74N
Lower Roots



DE-038
75
Lower Premolars



DE-039
86A
Lower Molars



DE-040
86B
lower molars



DE-041
86C
lower molars



DE-042
87
Lower Molars



DE-043
89
Upper Molars,
Right



DE-044
90
Upper Molars,
Left





EXTRACTING FORCEPS (English Pattern)

- Щипцы экстракционные (английская форма)
- Daviers (Forme Anglaise)
- Zahnzangen (Englische Form)

- Щипці екстракційні (англійська форма)
- Forceps de Extracción (Forme Inglesa)
- استخراج الملقط (نمط اللغة الإنجليزية)

A-TRAUMATIC EXTRACTION
Improved tapered beaks for complete root contact. Cross serrations.
Deep Gripe Extracting Forceps



- No Fracture
- No Tissue Damage
- Extraction With Easy

Thin Tip



**DE-045
34**
Upper incisors and
premolars
deep-gripping

Wide Tip



**DE-046
34A**
Upper centrals / cains
deep-gripping

Thin Tip



**DE-047
Fig. 35**
upper permolars
deep-gripping

Wide Tip



**DE-048
35A**
Upper incisors and
premolars
deep-gripping

Thin Tip



**DE-049
36**
Lower premolars
deep-gripping

Wide Tip



**DE-050
36A**
Lower premolars
deep-gripping



**DE-051
336**
lower permolars
deep-gripping



**DE-052
F-7C**
lower molar



**DE-053
9**
Apex Forceps Lower Universal
Deep Root Pick



**DE-054
79N**
Lower third molars
deep-gripping



**DE-055
79**
Lower Thrid Molars



EXTRACTING FORCEPS (English Pattern)



- Щипцы экстракционные (английская форма)
- Daviers (Forme Anglaise)
- Zahnzangen (Englische Form)

- Щипці екстракційні (англійська форма)
- Forceps de Extracción (Forme Inglesa)
- استخراج الملقط (نمط اللغة الإنجليزية)

DEEP GRIP FORCEPS



DE-056
146

Apex Forceps Lower Root
Deep Root Pick



DE-057
153

Apex Forceps Upper Root
Deep Root Pick



DE-058
149

Apex Forceps Upper Root
Deep Root Pick



DE-061
Fig. 44



DE-060
Fig. 44Z



DE-059
Fig. 45Z



DE-062
46XL
Apex Forceps Lower Root
Deep Root Pick



DE-063
67
Upper Third Molars



DE-064
67A
Upper Third Molars



DE-065
67N
Lower third molars
deep-gripping



DE-066
331
upper roots
deep-gripping





EXTRACTING FORCEPS (English Pattern)

- Щипцы экстракционные (английская форма)
- Daviers (Forme Anglaise)
- Zahnzangen (Englische Form)

- Щипці екстракційні (англійська форма)
- Forceps de Extracción (Forme Inglesa)
- استخراج الملقط (نمط اللغة الإنجليزية)

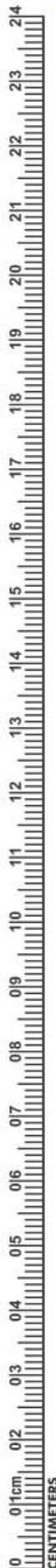

Fig. 1
upper
laterals
and canines



DE-067 Set of 10 Pieces

- Fig. 1
- Fig. 7
- Fig. 13
- Fig. 17
- Fig. 18
- Fig. 22
- Fig. 51A
- Fig. 67
- Fig. 74N
- Fig. 79

Fig. 7
upper
premolars



Fig. 13
lower
premolars



Fig. 17
upper
molars,
right



Fig. 18
upper
molars,
left



Fig. 22
lower
roots



Fig. 51A
upper roots



Fig. 67
upper third
molars



Fig. 74N
lower
molar



Fig. 79
lower third
molars



EXTRACTING FORCEPS

- Щипцы экстракционные
- Daviers
- Zahnzangen
- Щипці екстракційні
- Forceps de Extracción
- استخراج الملقط

Pediatric Tooth Extracting Forceps Set



DE-069
English Pattern Klein #51S
Pedodontic Upper root



DE-068
English Pattern Klein #137
Pedodontic, Upper Incisors Spring handle



DE-072
English Pattern Klein #5
Pedodontic Lower Incisors.



DE-070
English Pattern Klein #139
Pedodontic Upper Premolars

Baby Tooth Extraction Forceps



Fig. # 01 to 07
Set of 7 Pieces



DE-073
English Pattern Klein #7
Pedodontic Lower Roots,



DE-071
English Pattern Klein #3
Pedodontic Upper Molars Universal

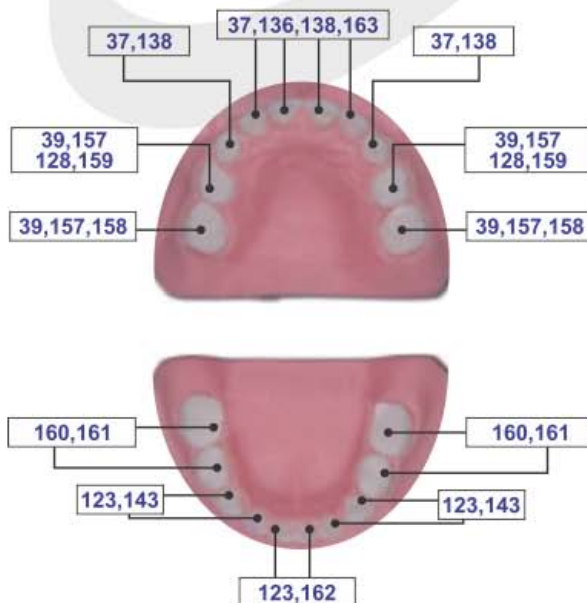

DE-074
English Pattern Klein #6
Pedodontic Lower Molars, Spring Handle



EXTRACTING FORCEPS (American Pattern)

- Щипцы экстракционные (американская форма)
- Daviers - forme américaine
- Fórceps de extracción - forma americana
- Щипці екстракційні (американська форма)
- Pinzoper per estrazione - forma americana
- استخراج المنقط (النمط الأمريكي)

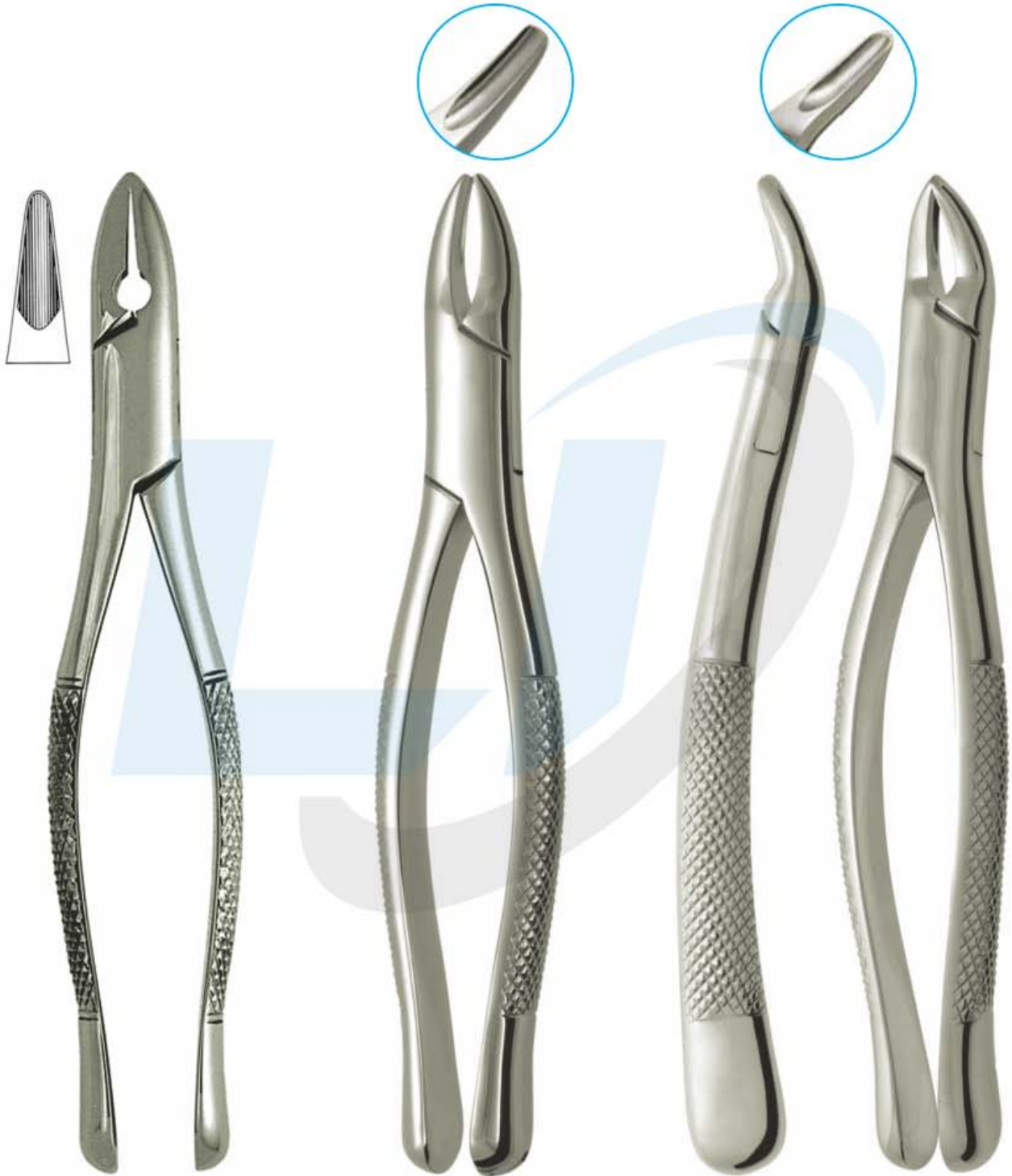

DE-075
1STD
Winter
upper centrals and canines

DE-076
Fig. 1
upper incisors
and roots

DE-077
Cryer
Fig. 150

EXTRACTING FORCEPS (American Pattern)



- Щипцы экстракционные (американская форма)
- Щипці екстракційні (американська форма)
- Daviers - forme américaine
- Pinzere per estrazione - forma americana
- Fórceps de extracción - forma americana
- استخراج الملقط (النمط الأمريكي)



DE-078
Fig. 150A
Cryer

upper incisors, premolars, roots



DE-079
Fig. 62

incisors, premolars,
deciduous teeth



DE-080
10S

upper roots



DE-081
17

lower molars



DE-082
Harris
Fig. 18R



DE-083
Harris
Fig. 18L



EXTRACTING FORCEPS (American Pattern)

- Щипцы экстракционные (американская форма)
- Daviers - forme américaine
- Fórceps de extracción - forma americana
- Щипці екстракційні (американська форма)
- Pinzener per estrazione - forma americana
- استخراج الملقط (النمط الأمريكي)



DE-084
Fig. 210
upper third molars



DE-085
Fig. 53R
upper molars, right



DE-086
Fig. 53L
upper molars, left



DE-087
NEVIUS
Fig. 88R



EXTRACTING FORCEPS (American Pattern)



- Щипцы экстракционные (американская форма)
- Щипці екстракційні (американська форма)
- Daviers - forme américaine
- Pinzere per estrazione - forma americana
- Férceps de extracción - forma americana
- استخراج الملقط (النمط الأمريكي)



DE-088
Fig. 24
upper molars



DE-089
210S
upper third molars



DE-090
210H
upper third molars



DE-091
286
Upper Roots,
Premolars, Incisors



DE-092
99C
Kells
upper incisors,
canines, premolars



DE-093
222
lower third molars



DE-094
286
Lower Molar



EXTRACTING FORCEPS (American Pattern)

- Щипцы экстракционные (американская форма)
- Daviers - forme américaine
- Fórceps de extracción - forma americana
- Щипці екстракційні (американська форма)
- Pinzaper per estrazione - forma americana
- استخراج الملقط (النمط الأمريكي)



DE-095
Nevius
Fig. 88L
upper molars, left



DE-096
Fig. 65
upper incisors
and roots



DE-097
Parmly Fig. 32A
upper premolars
and roots



DE-098
Parmly Fig. 32
upper premolars
and molars



EXTRACTING FORCEPS (American Pattern)

- Щипцы экстракционные (американская форма)
- Щипці екстракційні (американська форма)
- Daviers - forme américaine
- Pinzere per estrazione - forma americana
- Férceps de extracción - forma americana
- استخراج الملقط (النمط الأمريكي)

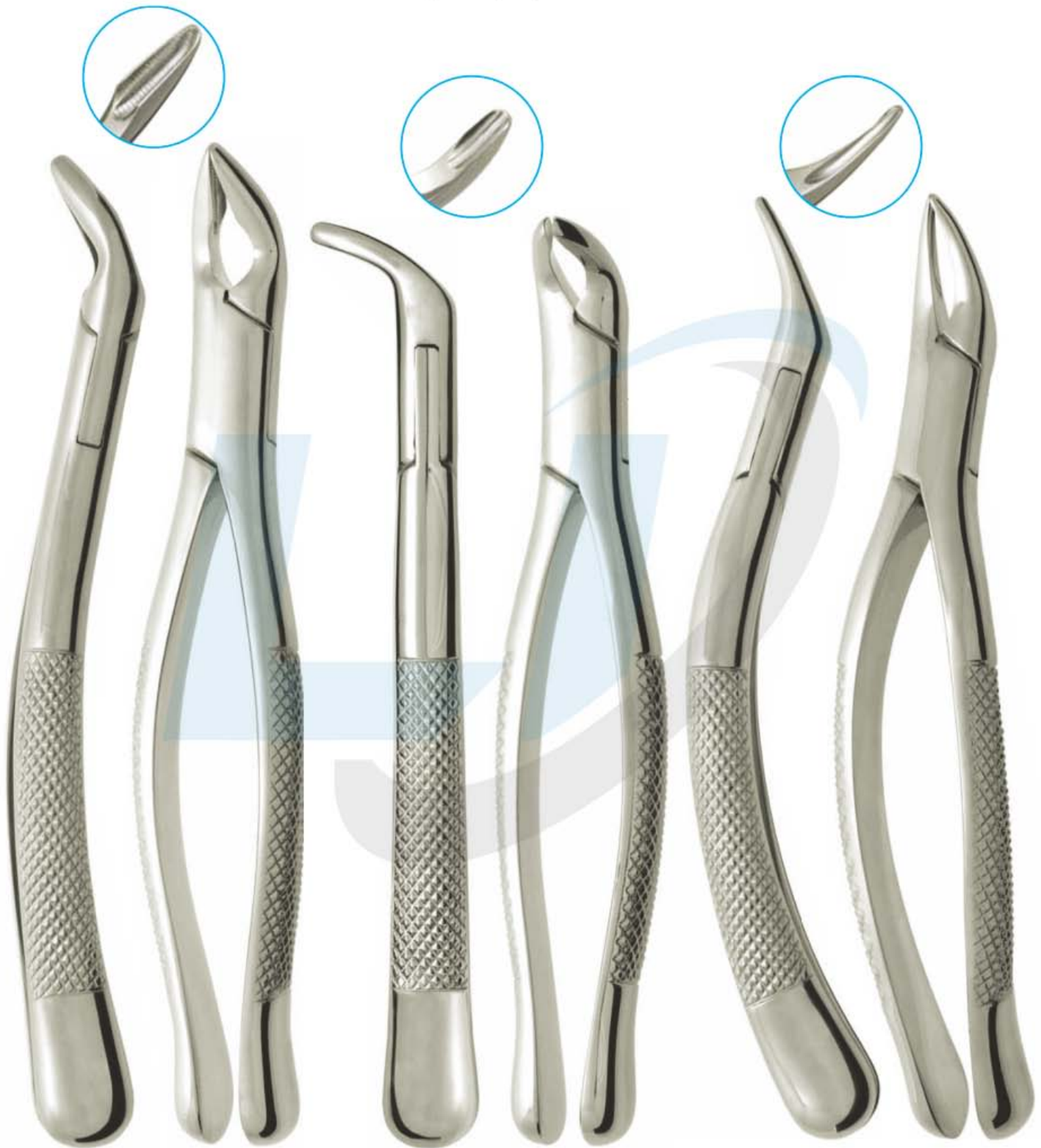

DE-099
COHEN
universal

DE-100
Fig. 203
lower incisors
and roots

DE-101
Tomes Fig. 69
upper and lower
roots

EXTRACTING FORCEPS (American Pattern)

- Щипцы экстракционные (американская форма)
- Daviers - forme américaine
- Fórceps de extracción - forma americana
- Щипці екстракційні (американська форма)
- Pinzoper per estrazione - forma americana
- استخراج الملقط (النمط الأمريكي)



DE-102
Fig. 23
lower molars

DE-103
Fig. 16
lower molars

DE-104
Physic Fig. 5
lower third molars

DE-105
Harris Fig. 15
lower molars

DE-106
Fig. 103

EXTRACTING FORCEPS (American Pattern)



- Щипцы экстракционные (американская форма)
- Daviers - forme américaine
- Fórceps de extracción - forma americana
- Щипці екстракційні (американська форма)
- Pinzere per estrazione - forma americana
- استخراج الملقط (النمط الأمريكي)



DE-107
Hull
Fig. 101
Deciduous teeth

DE-108
Cryer
Fig. 150S
upper teeth,
for children

DE-109
Fig. 150 AS



EXTRACTING FORCEPS (American Pattern)

- Щипцы экстракционные (американская форма)
- Daviers - forme américaine
- Fórceps de extracción - forma americana
- Щипці екстракційні (американська форма)
- Pinzaper per estrazione - forma americana
- استخراج المنقط (النمط الأمريكي)

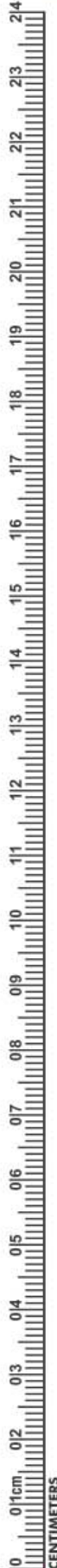

DE-110
Cryer
Fig. 151
lower teeth,
for children

DE-111
Fig. 151 S
lower incisors,
premolars, roots

DE-112
Fig. 151 AS

EXTRACTING FORCEPS (American Pattern)



- Щипцы экстракционные (американская форма)
- Щипці екстракційні (американська форма)
- Daviers - forme américaine
- Pinzere per estrazione - forma americana
- Férceps de extracción - forma americana
- استخراج الملقط (النمط الأمريكي)



DE-113
16S
lower molars for children



DE-114
17S
lower molars



DE-115
23 S
Lower molars

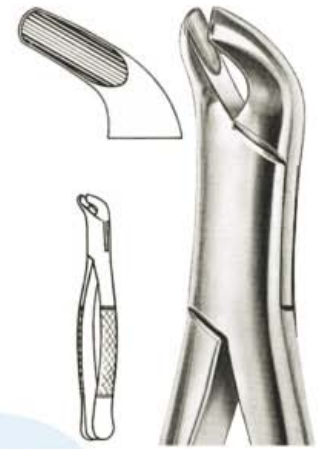

DE-116
27
lower molars



DE-117
18LS
upper molars left



DE-118
18RS
upper molars right



DE-119
85 Tomas
lower canines, premolars and molars



DE-120
85A Tomas
lower canines, premolars and molars



DE-121
69S
upper and lower roots

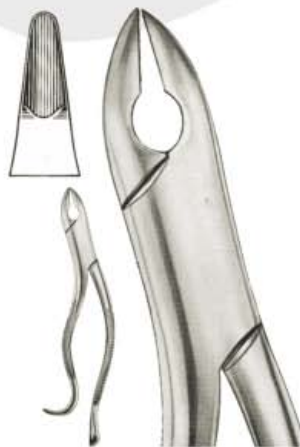

DE-122
99A Kells
upper incisors, canines, premolars



DE-123
217
lower molars





EXTRACTING FORCEPS (American Pattern)

- Щипцы экстракционные (американская форма)
- Daviers - forme américaine
- Fórceps de extracción - forma americana
- Щипці екстракційні (американська форма)
- Pinzere per estrazione - forma americana
- استخراج الملقط (النمط الأمريكي)



DE-124
#10 SK
Upper Molars Sup



DE-125
#17 SK Universal
Lower Molars



DE-126
#23 SK Universal
Upper Molars



DE-127
#69 SK Tomas
upper and lower roots



DE-128
#99 SK
upper incisors,
canines, premolars



DE-129
#150 SK
upper incisors,
premolars, roots



DE-130
#151 SK
lower incisors,
premolars, roots



DE-131
#222 SK
lower third molars

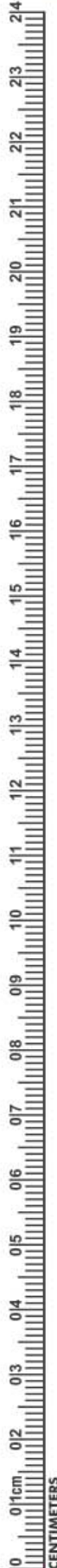

EXTRACTING FORCEPS (American Pattern)



- Щипцы экстракционные (американская форма)
- Daviers - forme américaine
- Férceps de extracción - forma americana
- Щипці екстракційні (американська форма)
- Pinzere per estrazione - forma americana
- استخراج الملقط (النمط الأمريكي)



DE-132
Fig. 1
Upper Anterior

DE-133
Lower Molar
Fig. 23 Cow Horn



DE-134
Fig. 74
Lower Anterior



DE-135
Fig. 88L
Upper Molar Left



DE-136
Fig. 88R
Upper Molar Right



DE-137
Fig. 74
Lower Anterior



DE-138
Fig. 106
Lower Incisors



DE-139
Fig. 174
Extra Narrow
Lower Anterior
Apical Retention
Forceps



DE-140
Fig. 859
Lower Molars
Roots





DENTAL SYRINGES



- Шприцы стоматологические карпульные
- Seringues à usage dentaire
- Dentalspritzen
- Шприці стоматологічні карпульні
- Jeringas dentales
- المحاقن الأسنان



DE-141 1.8ML
DE-142 2.2ML



DE-143 1.8ML
DE-144 2.2ML



DE-145 1.8ML
DE-146 2.2ML



DE-147 1.8ML
DE-148 2.2ML



DE-149 1.8ML
DE-149A 2.2ML



DE-149B 1.8ML
DE-149C 2.2ML



DE-149D
1001
Intraligamental
Anesthesia
Syringe in
Black Colour



DE-149E 1.8ML
DE-149F 2.2ML
Angled



DE-149G
Aluminium - Dark 1.8 ml

- DE-149H Aluminium - Silver 1.8 ml
- DE-149I Aluminium - Orange 1.8 ml
- DE-149J Aluminium - Green 1.8 ml
- DE-149K Aluminium - Blue 1.8 ml



Type C
DE1-149 1,8ml.
DE2-149 2,2ml



Type C
DE3-149 1,8ml
DE4-149 2,2ml



2-Ring
DE5-149 1,8ml.
DE6-149 2,2ml



Aspirating Syringe
DE7-149 1.8mm
DE8-149 2.2mm



Cartridge Syringe
DE9-149 1.8mm
DE10-149 2.2mm



Cartridge Syringe
DE11-149 1.8mm
DE12-149 2.2mm



Cartridge Syringe
DE13-149 1.8mm
DE14-149 2.2mm

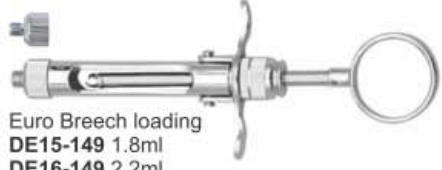

Euro Breech loading
DE15-149 1.8ml
DE16-149 2.2ml

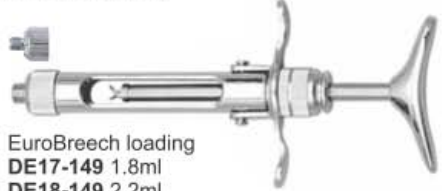

EuroBreech loading
DE17-149 1.8ml
DE18-149 2.2ml



Manual Aspirating Syringe
DE19-149 1.8ml
DE20-149 2.2ml



Quatro
DE21-149 1.8ml
DE22-149 2.2ml



Trio
DE23-149 1.8ml
DE24-149 2.2ml



Swedish Type
DE25-149 1.8ml
DE26-149 2.2ml



Ject Ultima
DE27-149 1.8ml
DE28-149 2.2ml
Injects 0,05 ml with every click Supplied with angled and straight tubes

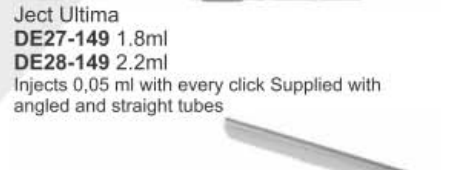

Ject angled
DE29-149 1.8ml
DE30-149 2.2ml



Ject Straight
DE31-149 1.8ml
DE32-149 2.2ml



Disc System
DE33-149 1.8ml
DE34-149 2.2ml



Disc System
DE35-149 1.8ml

BONE ROUNGER



- Костные кусачки
- Hohlmeißelzangen
- Pincas-gouges
- Кусачки для кісток
- Pinzas-gubias
- روتجیورس العظام



DE-149L
Blumenthal
15cm



DE-149M
Blumenthal
15cm



DE-149N
Blumenthal
15cm



DE-149O
Friedman
14cm



DE-149P
Friedman
14.5cm



DE-149Q
Micro-Friedman
14cm



DE-149R
Micro-Friedman
15cm



DE-149S
Micro-Friedman
16cm



DE-149T
Kleinert-Kutz
18.5cm



DE-149U
Beyer
18.5cm



DE-149V
Mead 1A
18.5cm



DE-149W
Luer
18.5cm





ROOT ELEVATORS

0 0.1cm 0.2 0.3 0.4 0.5 0.6 0.7 0.8 0.9 1.0 1.1 1.2 1.3 1.4 1.5 1.6 1.7 1.8 1.9 2.0 2.1 2.2 2.3 2.4
CENTIMETERS

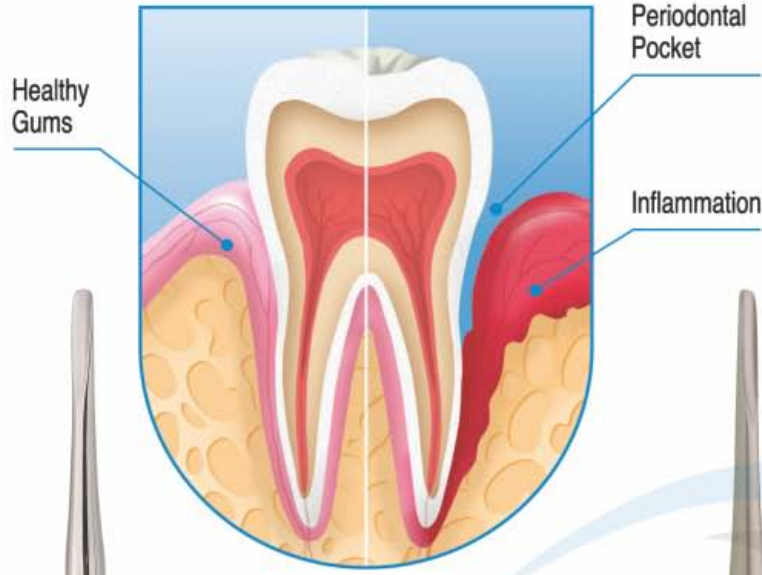

**HANDLES FOR ROOT ELEVATORS POINTS
A, B, C, D**

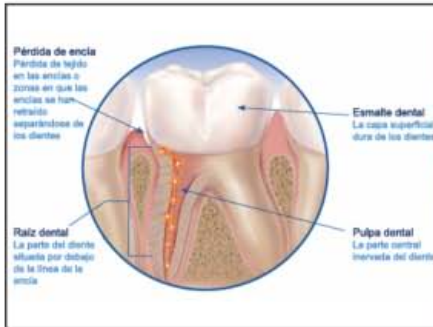

ROOT ELEVATOR



- Элеватор корневой экстракционный
- Elévateurs à racines
- Wurzelheber
- Слеватор корневий екстракційний
- Elevadores para raices
- المصاعد الجذر

Apexo Root Elevators



Apexo



DE-150
Apexo
2.5x9mm
Straight



DE-151
Apexo
2.7x9mm
Straight



DE-152
Apexo
3.0x9mm
Straight



DE-153
Apexo
2.5x9mm
Curved



DE-154
Apexo
3.0x9mm
Curved



DE-155
Seldin
3.0x14mm
Straight

Luxator Root Elevators



Luxator



DE-156
Luxator
3mm
straight



DE-157
Luxator
3mm
curved



DE-158
Luxator
4mm
straight



DE-159
Luxator
4mm
curved



DE-160
Luxator
5mm
straight



DE-161
Luxator
5mm
curved

Bein Root Elevators



Bein



DE-162
Bein 2mm



DE-163
Bein 3mm



DE-164
Bein 4mm

Seldin Root Elevators



Seldin



DE-165
Floh 1



DE-166
Seldin 34S



DE-167
Seldin 34



- Элеватор корневой экстракционный
- Elévateurs à racines
- Wurzelheber

- Elevator corneviu extracționii
- Elevadores para raices
- المصاعد الجذر

Apexo Root Elevators



Apexo



DE-168
Apexo
2.5x9mm
Straight



DE-169
Apexo
2.7x9mm
Straight



DE-170
Apexo
3.0x9mm
Straight



DE-171
Apexo
2.5x9mm
Curved



DE-172
Apexo
3.0x9mm
Curved



DE-173
Seldin
3.0x14mm
Straight

Luxator Root Elevators



Luxator



DE-174
Luxator
3mm
straight



DE-175
Luxator
3mm
curved



DE-176
Luxator
4mm
straight



DE-177
Luxator
4mm
curved



DE-178
Luxator
5mm
straight



DE-179
Luxator
5mm
curved

Bein Root Elevators



Bein



DE-180
Bein 2mm

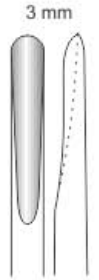

DE-181
Bein 3mm



DE-182
Bein 4mm

Seldin Root Elevators



Seldin

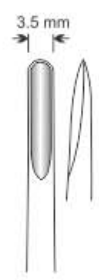

DE-183
Flohr 1



DE-184
Seldin 34S



DE-185
Seldin 34



ROOT ELEVATOR



- Элеватор корневой экстракционный
- Elévateurs à racines
- Wurzelheber
- Слеватор корневий екстракційний
- Elevadores para raices
- المعاعد الجذر

Apical Root Elevators

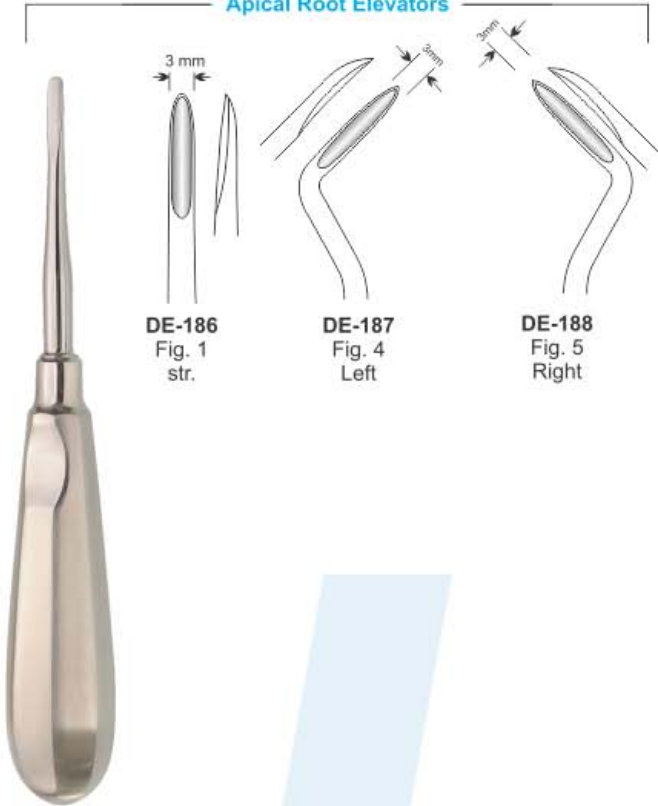

Apical Root Elevators

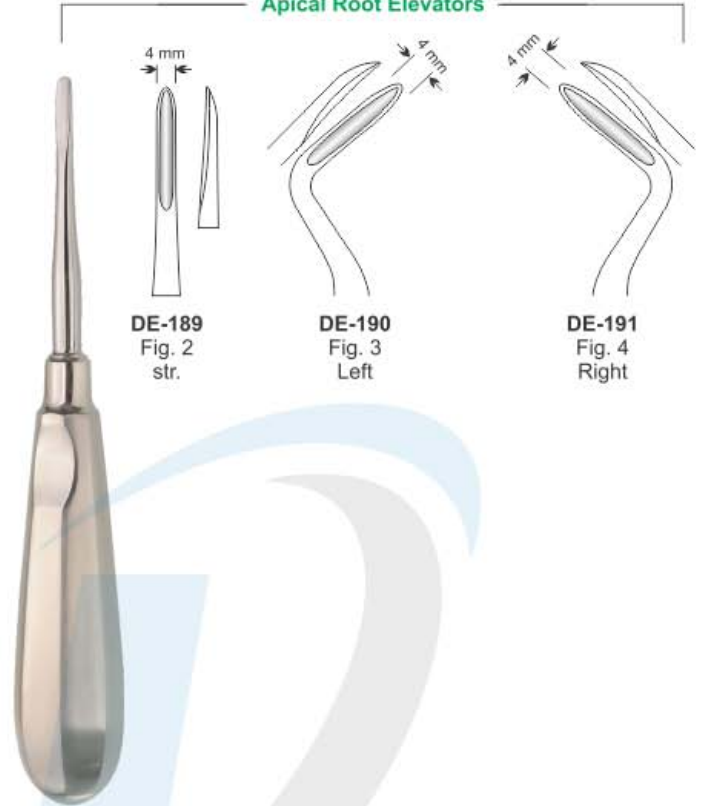

Coupland Root Elevators

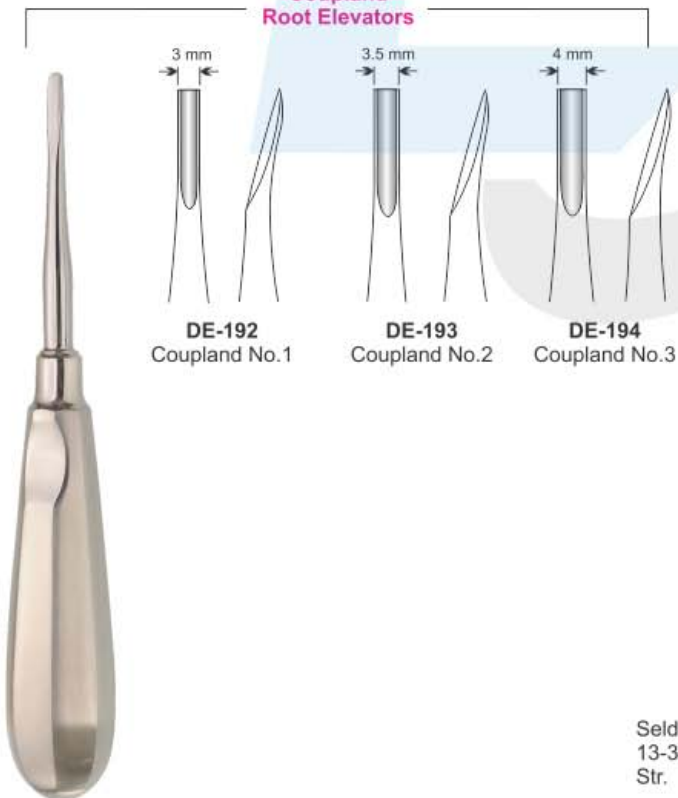

Seldin Root Elevators

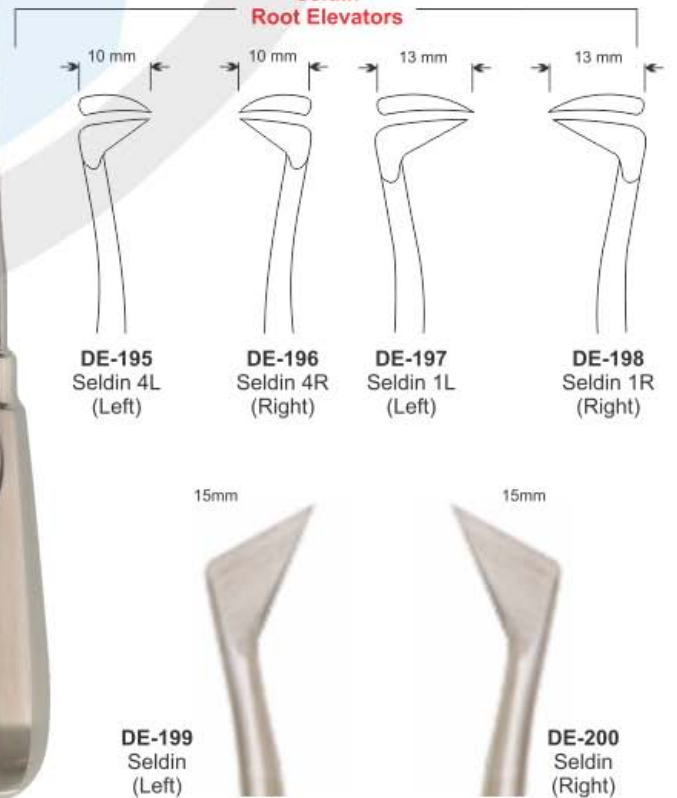

- Элеватор корневой экстракционный
- Elévateurs à racines
- Wurzelheber

- Elevator coronevii ekstraktsionnyy
- Elevadores para raices
- المصاعد الجذر

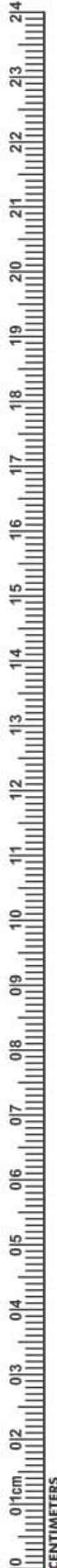

Apical Root Elevators

Apical Root Elevators

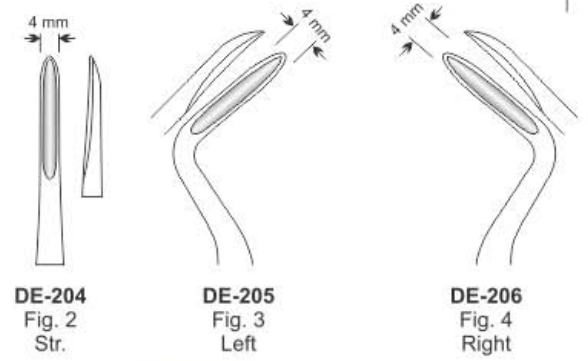
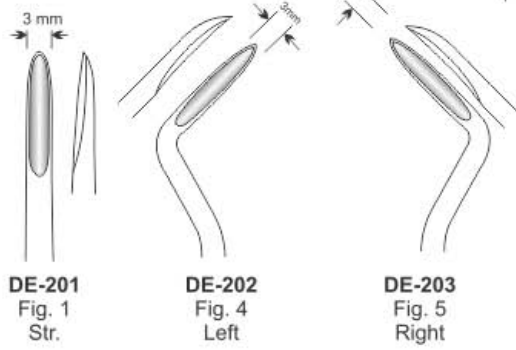

Coupland Root Elevators

Seldin Root Elevators

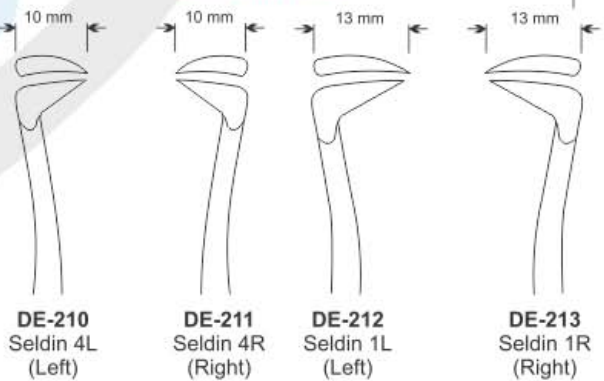
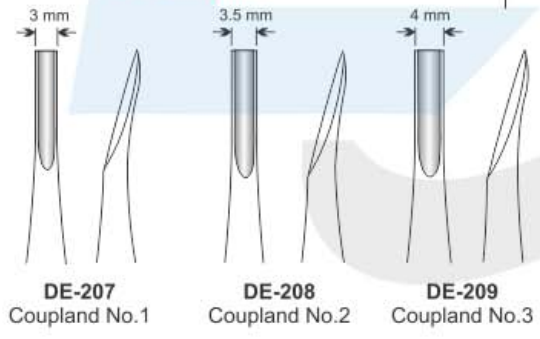

Coupland

Seldin 13-3 Str.



ROOT ELEVATOR



- Элеватор корневой экстракционный
- Elévateurs à racines
- Wurzelheber
- Слеватор корневий екстракційний
- Elevadores para raices
- المعاعد الجذر

Apical Root Elevators

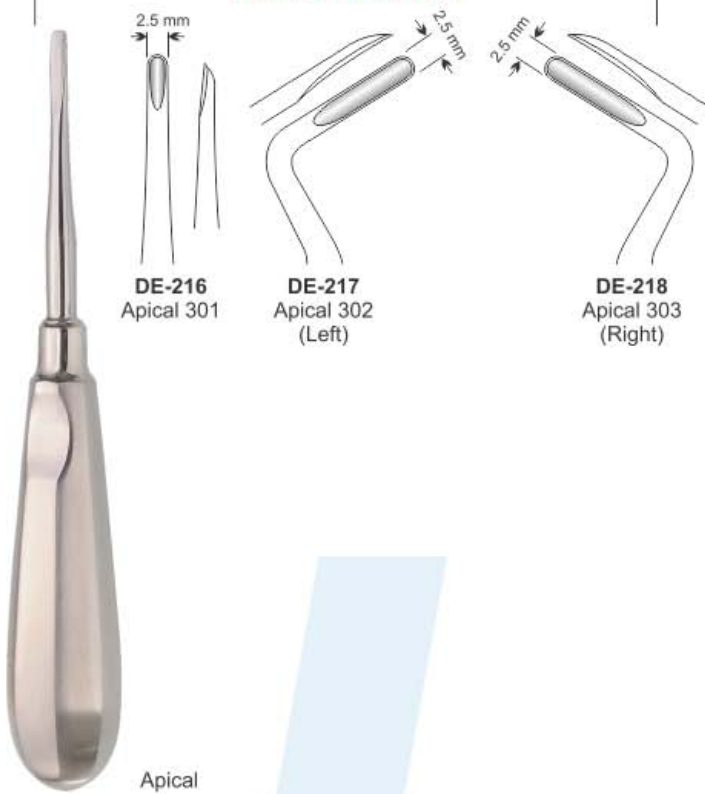

Apical Root Elevators

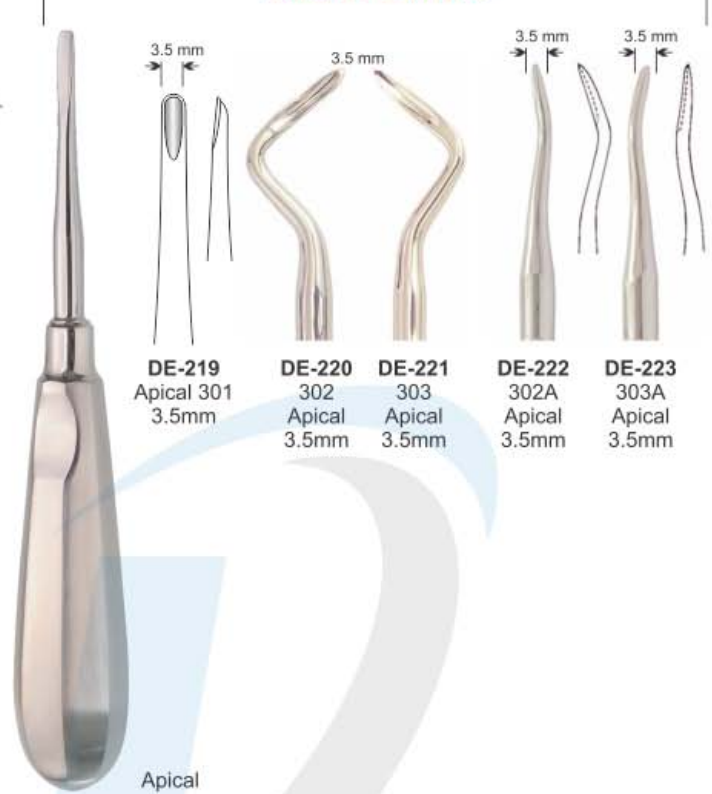

Apical Root Elevators



Laxutor Root Elevators





ROOT ELEVATOR

- Элеватор корневой экстракционный
- Elévateurs à racines
- Wurzelheber

- Elevator corneviu extracționiu
- Elevadores para raices
- المصاعد الجذر

Lindo Levian Root Elevators



Flohr Root Elevators

Heidbrink Root Elevators

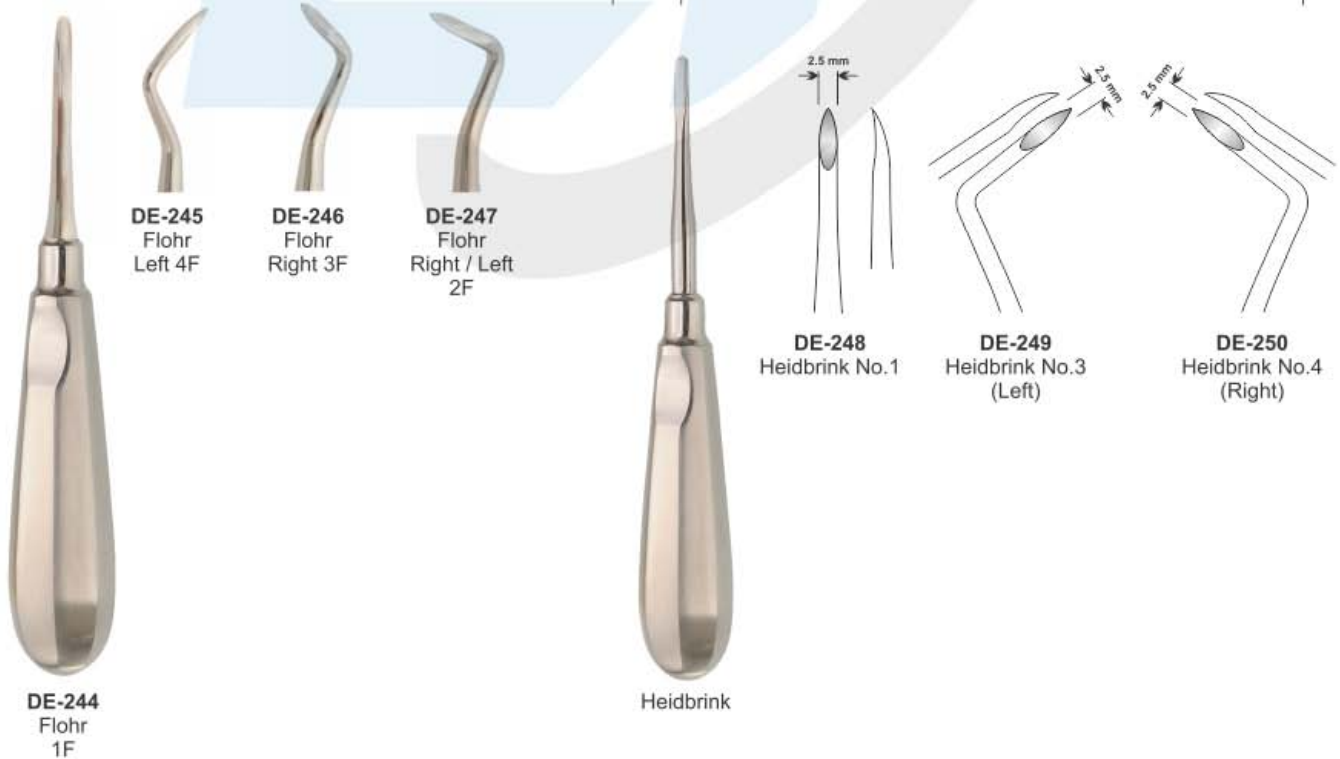

ROOT ELEVATOR



- Элеватор корневой экстракционный
- Elévateurs à racines
- Wurzelheber
- Слеватор корневий екстракційний
- Elevadores para raices
- المصاعد الجذر

Friedmann Roots Elevator



DE-251 Friedmann 4F Str.
DE-252 Friedmann 5F Left
DE-253 Friedmann 6F Right

Heidbrink Roots Elevator



DE-254 Heidbrink Straight
DE-255 Heidbrink Left
DE-256 Heidbrink Right

Wisdom Roots Elevator



DE-257 Wisdom for 18 and 38
DE-258 Wisdom for 28 and 48

Bayonet Roots Elevator Set



DE-259 Left
DE-260 Right
DE-261 bayonet
DE-262 Curved
DE-263 Straight

Luxator Roots Elevator



DE-264 Luxator Straight
DE-265 Luxator Curved





ROOT ELEVATOR

- Элеватор корневой экстракционный
- Elévateurs à racines
- Wurzelheber
- Слеватор корневий екстракційний
- Elevadores para raices
- المصاعد الجذر

Roots Elevator



DE-267
61

DE-268
62

DE-269
63

DE-266
60

Luxier Roots Elevator



DE-270
Luxier
3mm, Straight

DE-271
Luxier
3mm, Curved

DE-272
Luxier
5mm, Stright

DE-273
Luxier
3mm, Angular

Luxier Roots Elevator

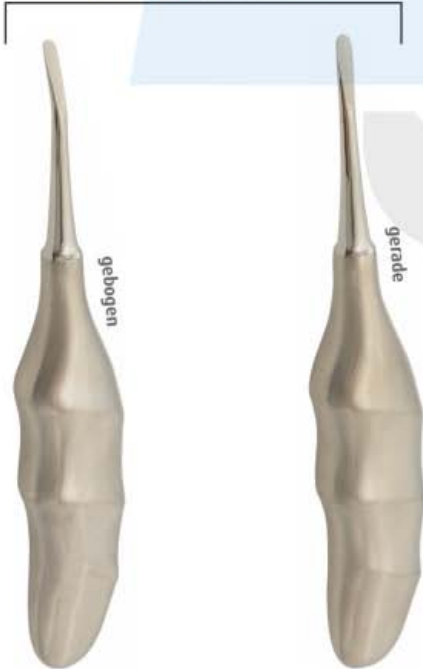

DE-274
Luxier
Cvd.

DE-275
Luxier
Str.

Claw-Lift Roots Elevator



DE-276
Claw-Lift
Right

DE-277
Claw-Lift
Left



ROOT ELEVATOR



- Элеватор корневой экстракционный
- Elévateurs à racines
- Wurzelheber
- Слеватор корневий екстракційний
- Elevadores para raices
- المصاعد الجذر

Hysin Roots Elevator

Cryer Roots Elevator



Kopp Roots Elevator



- Элеватор корневой экстракционный
- Elévateurs à racines
- Wurzelheber

- Єлеватор кореневий екстракційний
- Elevadores para raices
- المصاعد الجذر

Kopp Roots Elevator



DE-295
Kopp
Right



DE-296
Kopp
Left

Heber Roots Elevator



DE-297
Heber
Bayonet



DE-298
Heber
Bayonet

Bein Roots Elevator



DE-299
Bein,
3mm



DE-300
Bein,
4mm

Bein Roots Elevator



DE-301
Bein
2mm, curved
serrated



DE-302
2mm
straight
serrated



DE-303
3mm
straight



DE-304
4mm
Curved



DE-305
Bein
2mm, curved
serrated



DE-306
2mm
straight
serrated



DE-307
3mm
straight



DE-308
4mm
Curved



DE-309
Bein
2mm, curved
serrated



DE-310
2mm
straight
serrated



DE-311
3mm
straight



DE-312
4mm
Curved



ROOT ELEVATOR



- Элеватор корневой экстракционный
- Elévateurs à racines
- Wurzelheber
- Слеватор корневий екстракційний
- Elevadores para raices
- المصاعد الجذر

Seldin Roots Elevator



W. Barry Roots Elevator



Winter Roots Elevator



Pott Roots Elevator



- Элеватор корневой экстракционный
- Elévateurs à racines
- Wurzelheber

- Elevator corneviu extracționiu
- Elevadores para raices
- المصاعد الجذر

Heidbrink Roots Elevator



DE-338
Heidbrink
Straight

DE-339
Heidbrink
Left

DE-340
Heidbrink
Right

DE-341
Heidbrink
Straight

DE-342
Heidbrink
Left

DE-343
Heidbrink
Right

Syndesmotomes Roots Elevator



DE-344
Straight

DE-345
Left

DE-346
Right

Periotome Roots Elevator

Syndesmotomes



DE-347
Periotome
2.1mm
Straight

DE-348
Periotome
2.6mm
Straight

DE-349
Periotome
2.1mm
Angular

DE-350
Periotome
2mm
Curved

DE-351
Periotome
2.0mm

DE-352
Periotome
2.5mm

DE-353
Periotome
3.0mm

DE-354
Periotome
4.0mm



ROOT ELEVATOR



- Элеватор корневой экстракционный
- Elévateurs à racines
- Wurzelheber
- Слеватор корневий екстракційний
- Elevadores para raices
- المصاعد الجذر



DE-355
1S
(Straight 1mm)



DE-356
2S
(Straight 2mm)



DE-357
3S
(Straight 3mm)



DE-358
5S
(Straight 5mm)



DE-359
3C
(Curved 3mm)



DE-360
5C
(Curved 5mm)



DE-361
3CA
(Curved Angle 3mm)



DE-362
3IC
(Inverted Curved 3mm)



DE-363
DE 3
(Dual Edge 3mm / 1.5mm)



DE-364
DE 5
(Dual Edge 5mm / 3mm)





ROOT ELEVATOR

- Элеватор корневой экстракционный
 - Elévateurs à racines
 - Wurzelheber
- PDL ELEVATORS**

- Єлеватор кореневий екстракційний
- Elevadores para raices
- المصاعد الجذر



DE-365
PDL Elevators
Set of 7 Pcs

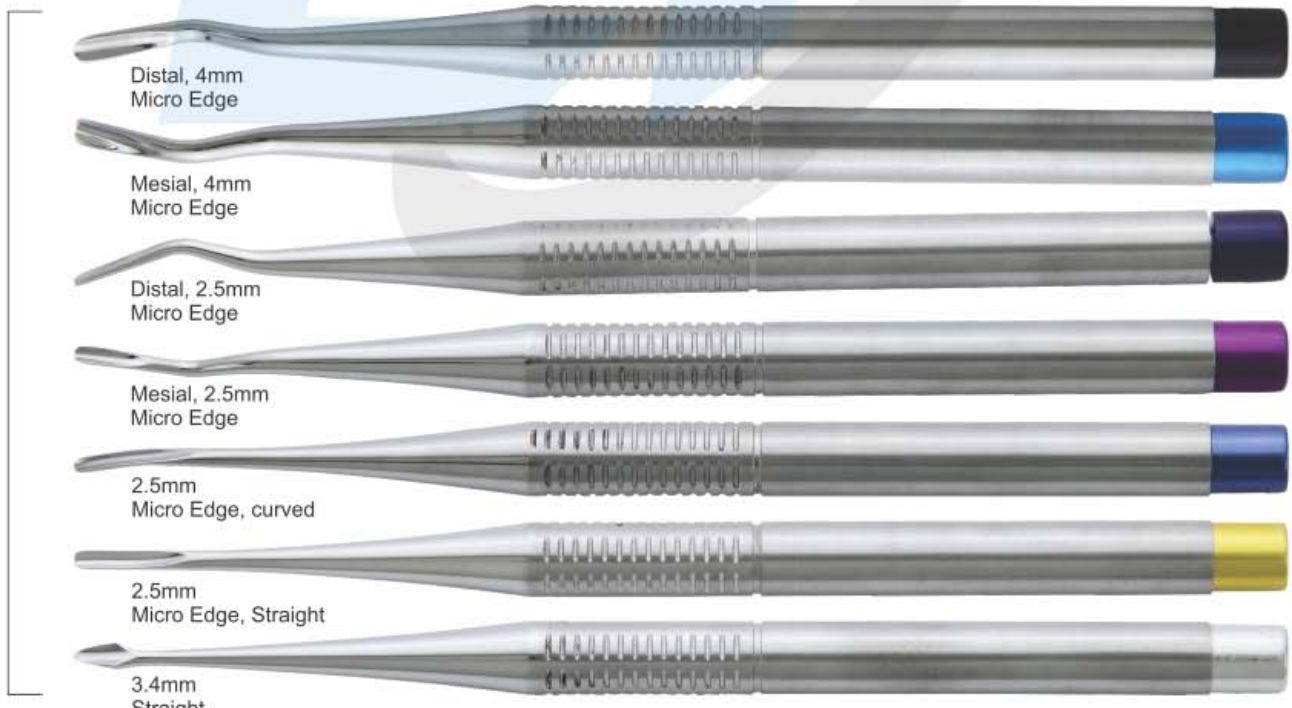

DE-366
PDL Elevators
Set of 7 Pcs

ROOT ELEVATOR



- Элеватор корневой экстракционный
- Elévateurs à racines
- Wurzelheber
- Слеватор корневий екстракційний
- Elevadores para raices
- المصاعد الجذر

PDL ELEVATORS

Delicate Arrow tip



4,0mm straight
4,0mm curved

Luxivators straight
atraumatic luxation of the tooth



2,5mm straight
3,5mm straight
4,5mm straight

Luxivators curved
atraumatic luxation of the tooth



2,5mm curved
3,5mm curved
4,5mm curved



DE-367
PDL Elevators
Set of 8 Pcs





Our Scalers

Compare our scalers and curettes with the best in the industry and you will immediately recognize we are equal in every way but one... price. Note the deep precision knurling for better tactile feel. The same high-grade stainless steel tips, the same light weight (under 18 grams) for less hand fatigue, the same professional craftsmanship, and surpassing the highest industry standards. of course, any manufacturer can make these claims, but we guarantee and certify ours.



Healthy

Periodontal Disease

Healthy Gums

Healthy Attachment and Bone Levels

Periodontal Prob

Plaque Bacteria Biofilm

Calculus / Tartar

Periodontal Pocke

Reduced Attachmen and Bone Level!

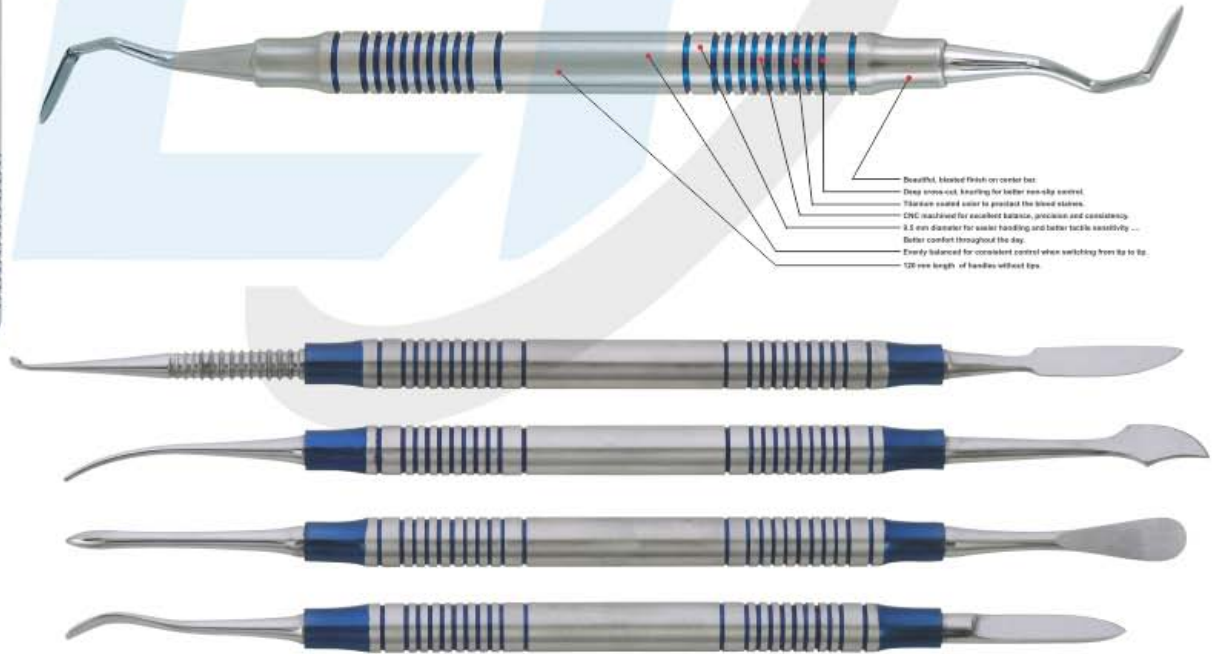
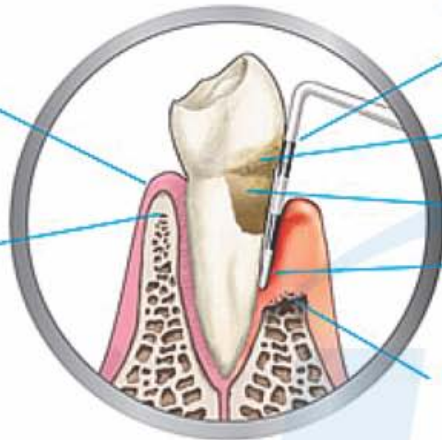

- Beautiful, blued finish on center bar
- Deep groove-out knurling for better non-slip control
- Titanium coated color to protect the blued surface
- CNC machined for excellent balance, precision and consistency
- 2.2 mm diameter for easier handling and better tactile sensitivity ...
- Better comfort throughout the day
- Evenly balanced for consistent control when switching from file to file
- 120 mm length of handles without tips

- High-polish mirror finish tips.
- Manufactured within the guidelines of the FDA quality assurance system for good manufacturing practices.
- Highest grade German stainless steel, razor sharp, durable tips. Rockwell hardened to 60 RHc.
- 27 of the most popular designs from graceys to McCalls to cumbias, and many european patterns.
- All instruments are guaranteed against defects in material and workmanship.

- All instruments bear the ce mark, emblematic of the european community's highest standards.
- Customer satisfaction guarantee, too!
- Less than 20 grams ... Lightweight for less hand fatigue.
- Manufactured to the most exacting standards so the 50th instrument you buy is exactly like your first.
- You decide ... Why pay more for the same high-quality instruments?

HANDLES FOR MOUTH MIRRORS

- Ручки для зеркал
- Manches pour miroirs à bouche
- Mundspiegelgriffe
- Ручки для дзеркал
- Mangos para espejos de boca
- مقابض لمرايا الفم



Magnifying

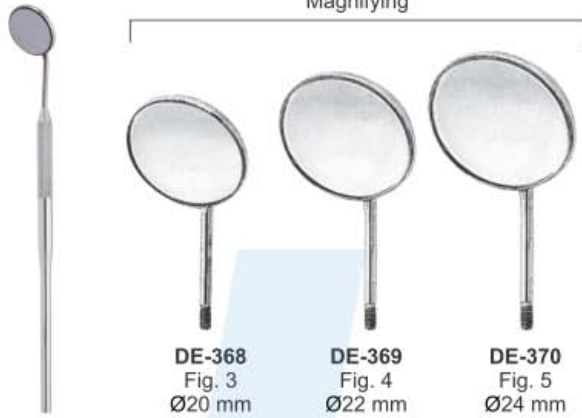

DE-368
Fig. 3
Ø20 mm

DE-369
Fig. 4
Ø22 mm

DE-370
Fig. 5
Ø24 mm

Plain

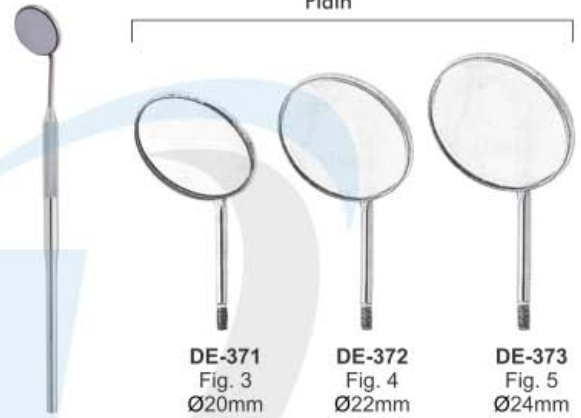

DE-371
Fig. 3
Ø20mm

DE-372
Fig. 4
Ø22mm

DE-373
Fig. 5
Ø24mm



Rhodium



DE-374
Fig. 3
Ø20mm

DE-375
Fig. 4
Ø22mm

DE-376
Fig. 5
Ø24 mm



DE-377 Hollow Mirror Handle Stem Extra Light (7.5mm) Length 5"



DE-378 Mirror Handle Stem Octagonal (6mm) Length 5"



DE-379 Mirror Handle Stem Round (6mm) Length 5"



DE1-380 Solid 12cm



DE2-380 Solid



DE3-380 Mirror Handle Stem with Rule 35mm (6mm) Length 5"



DE-380 Mirror Handle Stem with Rule 35mm (6mm) Length 5"



- Пинцеты
- Prêcelles - Brucelles
- Zahnpinzetten

- Пинцети
- Pinzas para algodón
- ملاقط



DE-381
Surgical
11.5cm



DE-382
London College
15cm



DE-383
Semken Taylor
Str.



DE-384
Semken Taylor
Cvd.



DE-385
Meriam
16cm



DE-386
Dressing
14cm



DE-387
Semken Taylor
1x2 Straight



DE-388
Semken Taylor
1x2 Curved



DE-389
Gilles
15cm 1x2



DE-390
14cm 1x2



DE-391
Perry
13cm



DE-392
Atraumatic
15cm Cvd



DE-393
Atraumatic
15cm Str.



DE-394
College with Lock
15cm Cvd.



DE-395
Gerald
17.5cm



DE-396
with lock
15cm



DE-397
Atraumatic
17.5cm



TWEEZERS



- Пинцеты
- Précelles - Brucelles
- Zahnpinzetten
- Пинцети
- Pinzas para algodón
- ملاقط



DE-398
Adson-TC
12cm

DE-399
Adson-TC
12cm 1x2

DE-400
Adson-TC
15cm 1x2

DE-401
Adson
12cm

DE-402
Adson
12cm 1x2

DE-403
Adson
15cm 1x2

DE-404
Adson Brown
12cm

DE-405
Crane Kaplan
15cm

DE-406
Crane Kaplan
15cm

DE-407
Crane Kaplan
15cm

DE-408
Hemingway
15cm

DE-409
Miller
15cm Str.

DE-410
Miller
15cm Cvd.

DE-411
Dressing
Tweezer
14.5cm

DE-412
College
Curved
Tip 15cm

DE-413
Maryam
Tweezers
15cm

DE-414
College
Tweezer
15cm

DE-415
Perry
Tweezer
12.5cm

DE-416
Self-locking
Tweezer
15cm

- Зонды
- Sondes
- Zahnsonden
- Зонди
- Sondas
- المستكشفين

Single Ended Probe Solid Handle 4.5mm Length 150mm

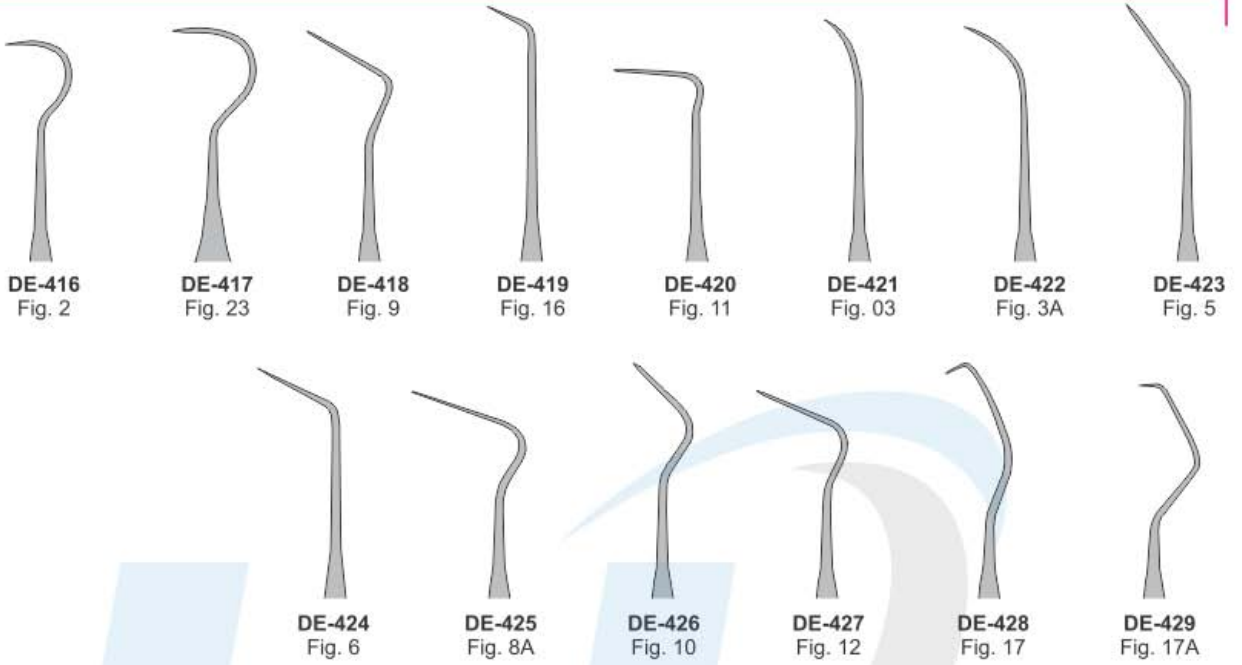

Fig. 2
Normal Handle

Single Ended Probe Hollow Handle 8.5mm Length 150mm

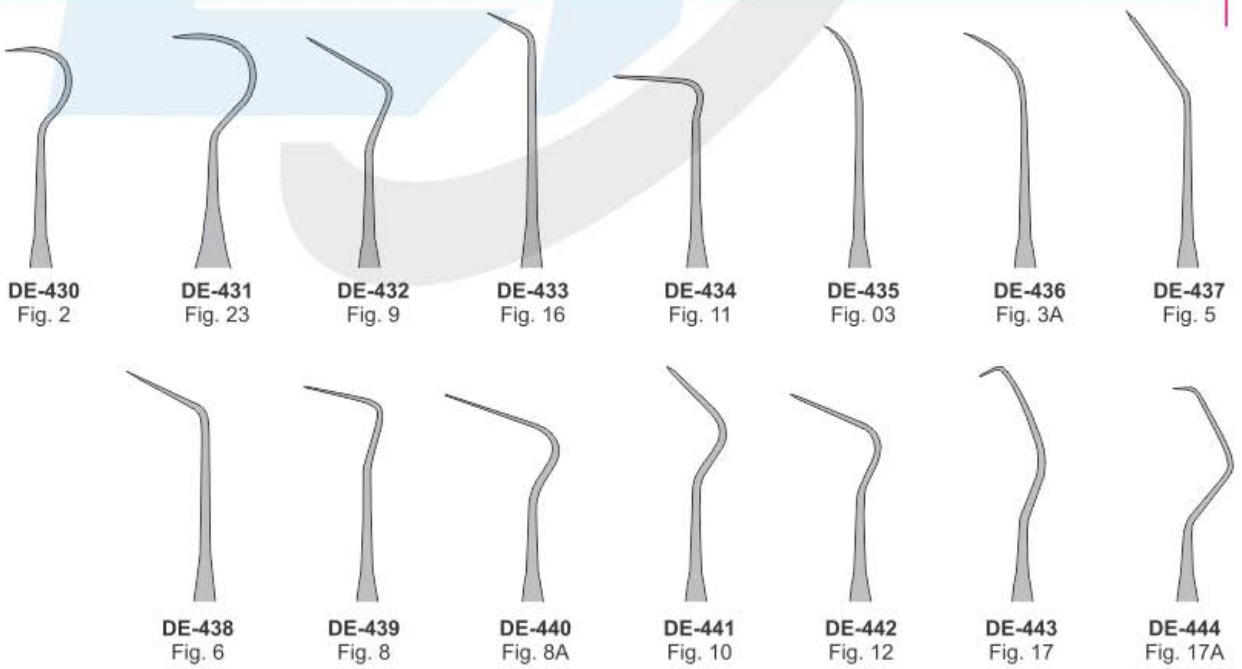

Fig. 2
Anatomic Handle



EXPLORERS



- Зонды
- Sondes
- Zahnsonden
- Зонди
- Sondas
- المستكشفين

Probes Single End Solid Handle 6mm, length 150mm

Probes Single Ended 6mm, length 150mm

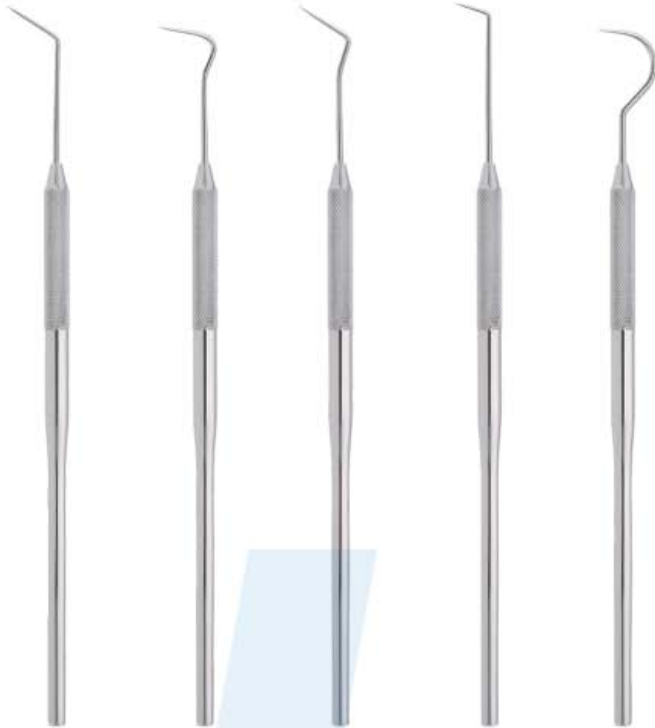

DE-445 Fig. 6 DE-446 Fig. 8 DE-447 Fig. 9 DE-448 Fig. 16 DE-449 Fig. 23

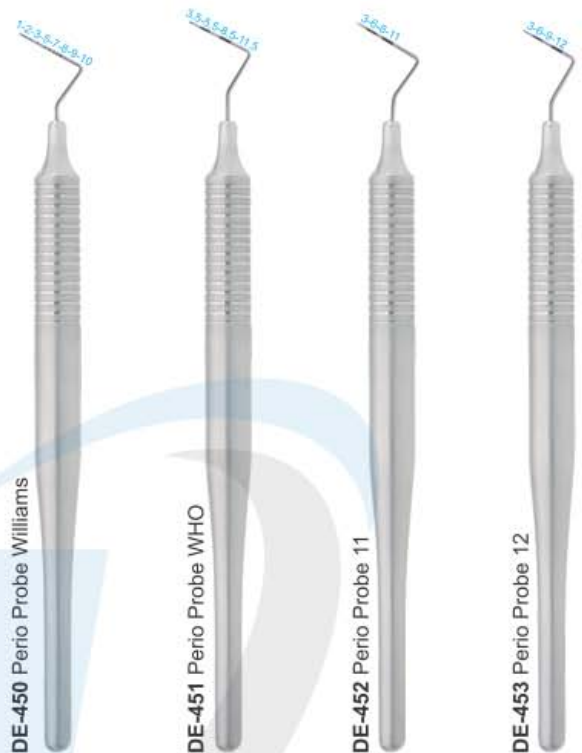

DE-450 Perio Probe Williams DE-451 Perio Probe WHO DE-452 Perio Probe 11 DE-453 Perio Probe 12

Examination kit Set of 3 Pieces

Examination Set of 4 Pieces

Examination Set of 4 Pieces



DE-454 Probe DE-455 Mirror DE-456 College Forcep 15cm



DE-457 Exp,23/17-A DE-458 Exavators DE-459 Tweezers DE-460 Mouth Mirror



EXPLORERS INSTRUMENTS SOLID HANDLE 6MM, LENGTH 170MM

- Зонды
 - Sondes
 - Zahnsonden
- Зонди
 - Sondas
 - المستكشفين



Explorers-Single-End

DE-461
23
Shepherd's
Hook
Explorer
#30, #6, #7, #8

Double-Ended Explorers

Tip Size: 1/1

Solid Handle Size 4.25"

DE-462
#5, #6
Explorer

DE-463
TU 17/23
Wilkins/Tufts
Explorer
#6

DE-464
23/UNC1
university of north
carolina
Explorer #31, #6, #7, #8

DE-465
1
#31, #6

DE-466
DG 16
#31, #6, #7
Thick, #6

DE-467
DG 16/23

DE-468
DG 16/17

DE-469
1
Abou-Rass
Explorers

Probes Double Ended 6mm, length 170mm

DE-470
Goldman Fox
Fig.17

DE-471
University
of Michigan
Fig.17

DE-472
Williams
Fig.17

DE-473
Goldman Fox
Fig.16

DE-474
University
of Michigan
Fig.16

DE-475
Williams
Fig.16

EXPLORERS



- Зонды
- Sondes
- Zahnsonden
- Зонди
- Sondas
- المستكشفين

Pointed Probes Single Ended Handle 6mm, length 150mm



Pointed Probes Double Ended Handle 6mm, length 170mm



- Инструменты пародонтологические
- Instruments pour la parodontologie
- Instrumente für die Parodontologie

- Інструменти пародонтологічні
- instrumentos para periodoncia
- الصكوك اللثة

PERIODONTAL SET OF 10 PIECES SOLID HANDLE 6MM LENGTH 170MM

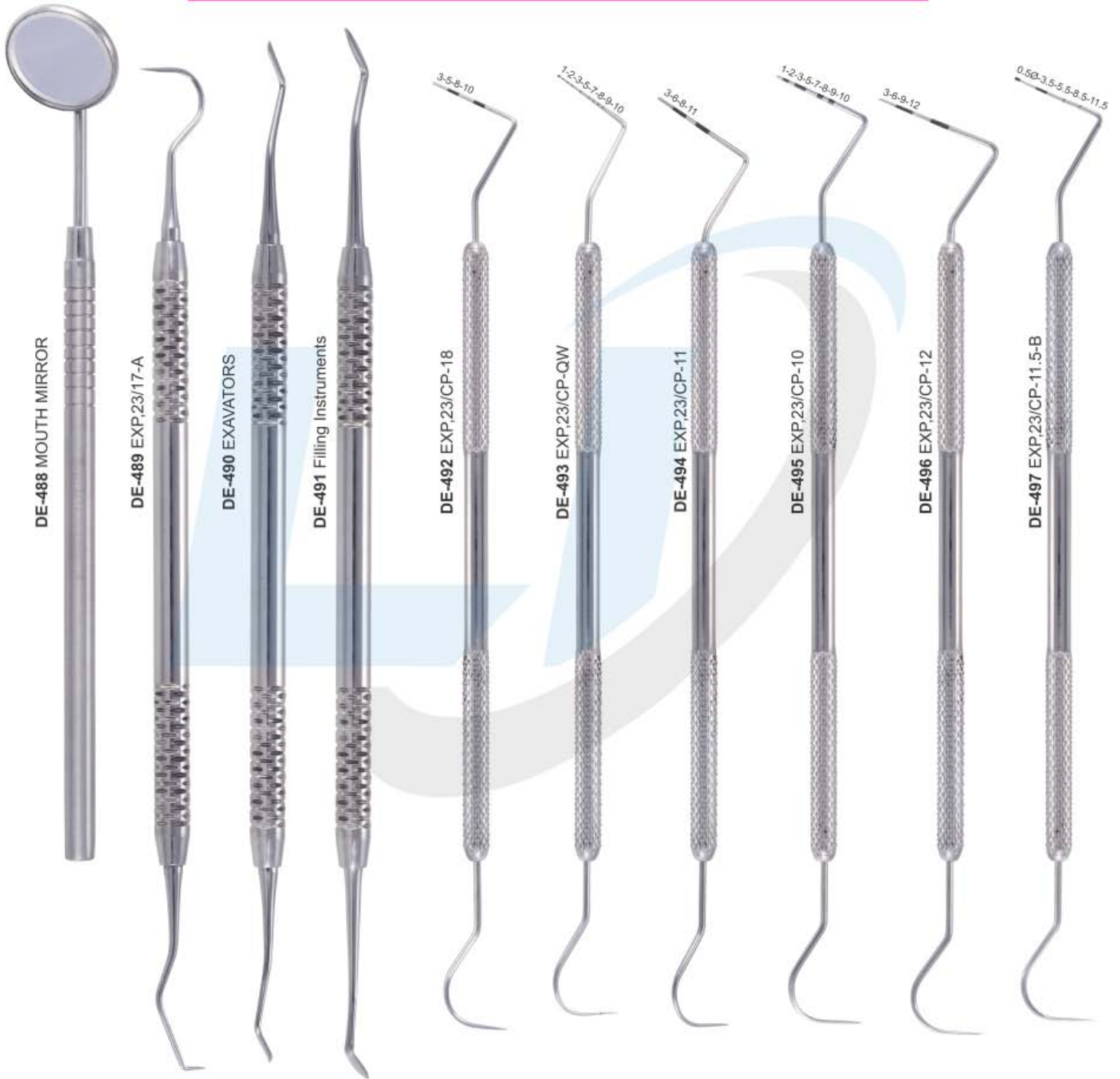

DE-488 MOUTH MIRROR

DE-489 EXP,23/17-A

DE-490 EXAVATORS

DE-491 Filling Instruments

DE-492 EXP,23/CP-18

DE-493 EXP,23/CP-QW

DE-494 EXP,23/CP-11

DE-495 EXP,23/CP-10

DE-496 EXP,23/CP-12

DE-497 EXP,23/CP-11.5-B

3-5-8-10

1-2-3-5-7-8-9-10

3-6-8-11

1-2-3-5-7-8-9-10

3-6-8-12

0.5-3-5-5-8-5-11.5

CURETTES



- Кюрети
- Curetas
- Küretten
- Кюрети
- Curette
- کرتس

SICKLE SCALERS

Designed for the removal of supragingival calculus

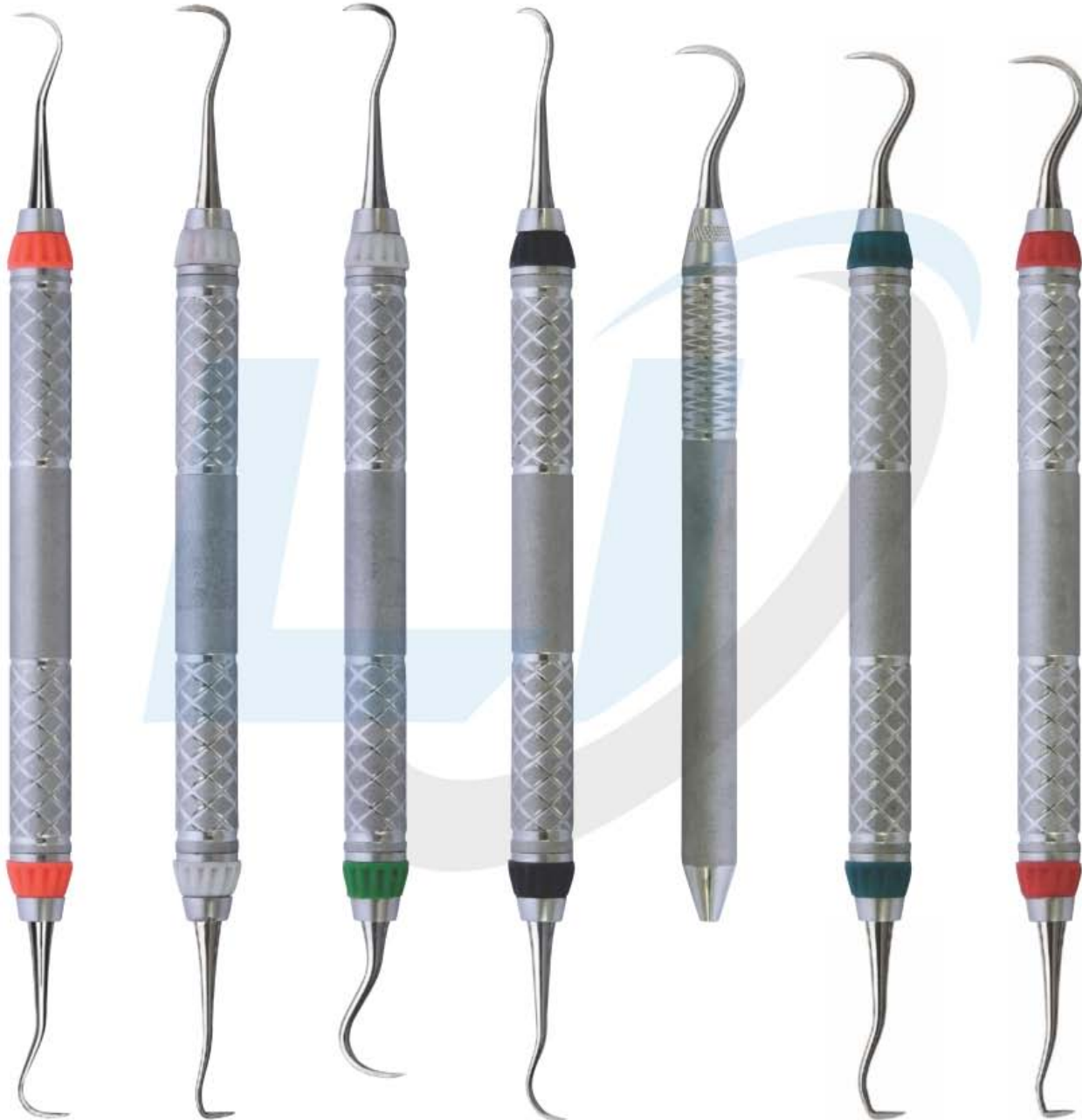

D1-001
H6/H7
Hygienist

D1-002
H5/33
Hygienist-
Jacquette

D1-003
H5/U15
Hygienist-
Towner

D1-004
6/7
Goldman

D1-005
U15
Towner

D1-006
U15/30
Towner-
Jacquette

D1-007
U15/33
Towner-
Jacquette





CURETTES

- Кюрети
- Curetas
- Küretten
- Кюрети
- Curette
- کرتس



SCALERS

JACQUETTE SCALERS

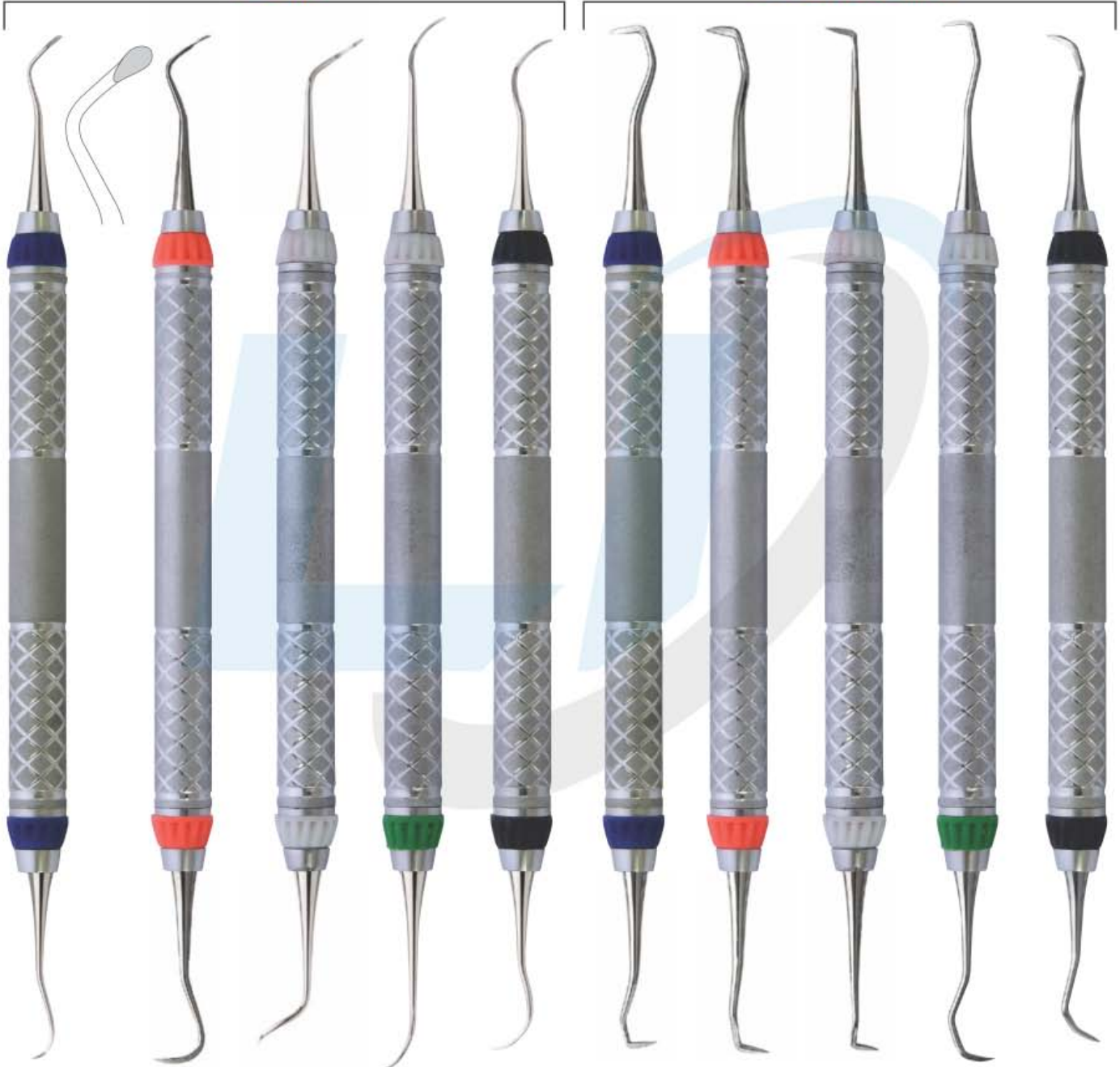

D1-008 Nevi 1 Anterior	D1-009 Nevi 1/H5 Anterior	D1-010 Nevi 2 Posterior	D1-011 Nevi 3 Posterior	D1-012 Nevi 4 Posterior	D1-013 30/33 Jacquette	D1-014 31/32 Jacquette	D1-015 34/35 Jacquette	D1-016 H3/H4 Jacquette	D1-017 14/15 Posterior
-------------------------------------	--	--------------------------------------	--------------------------------------	--------------------------------------	-------------------------------------	-------------------------------------	-------------------------------------	-------------------------------------	-------------------------------------

CURETTES



- Кюрети
- Curetas
- Küretten
- Кюрети
- Curette
- کرتس

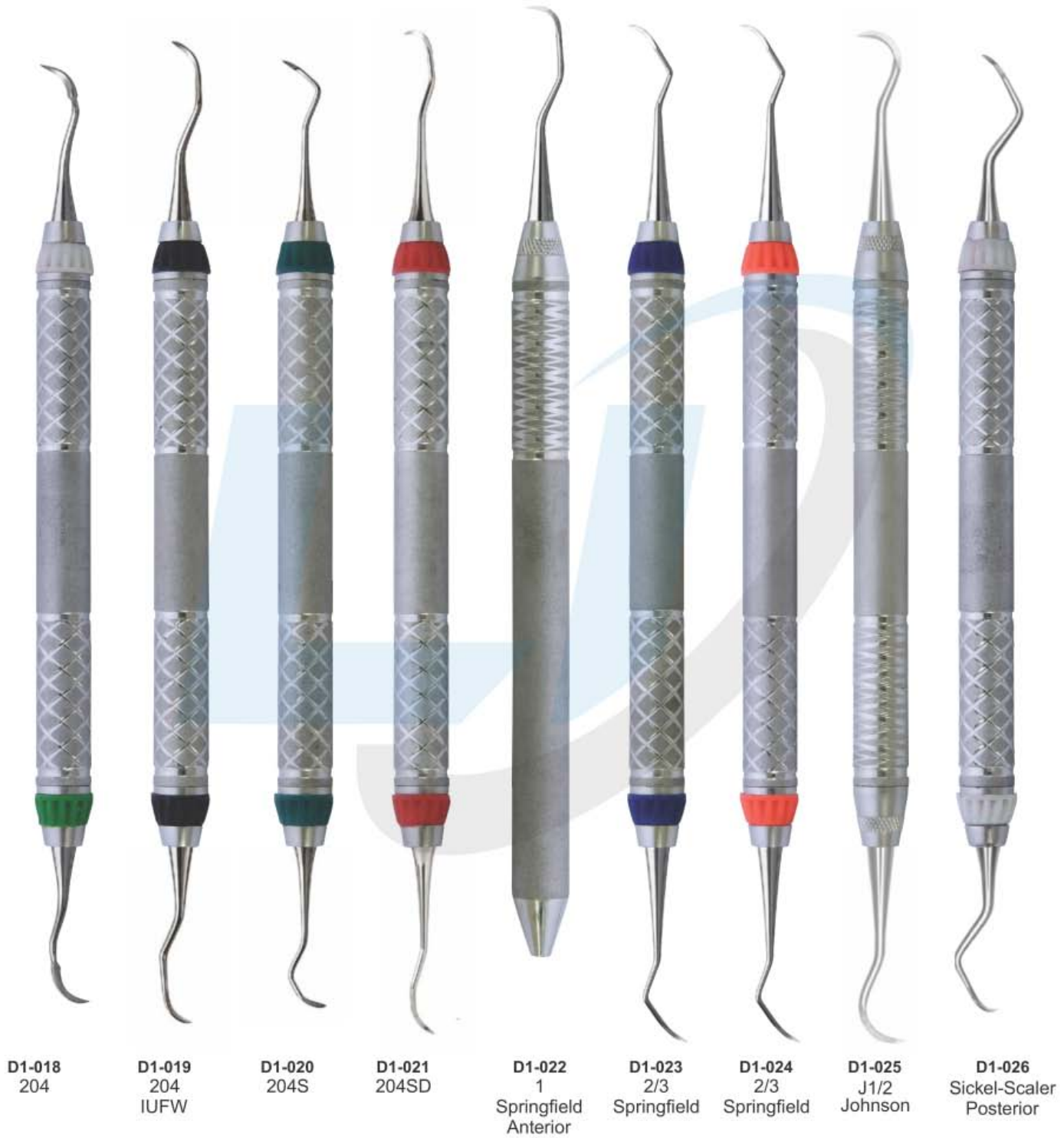

D1-018
204

D1-019
204
IUFW

D1-020
204S

D1-021
204SD

D1-022
1
Springfield
Anterior

D1-023
2/3
Springfield

D1-024
2/3
Springfield

D1-025
J1/2
Johnson

D1-026
Sickel-Scaler
Posterior

- Кюрети
- Curetas
- Küretten
- Кюрети
- Curette
- کرتس

SICKLE SCALERS

POSTERIOR

ANTERIOR



D1-027
135



D1-028
REM 3/4
Remington



D1-029
129



D1-030
T2/T3
Taylor



D1-031
137



D1-032
0/00
Morse



CURETTES



- Кюрети
- Curetas
- Küretten
- Кюрети
- Curette
- كرتس



D1-033
137
Mini Five



D1-034
OD1/33
Odont/
Jacquette



D1-035
128
Nebraska



D1-036
USC-128



D1-037
WH-2
Whiteside



D1-038
YG-15
Younger-
Good





CURETTES

- Кюрети
- Curetas
- Küretten
- Кюрети
- Curette
- کرتس

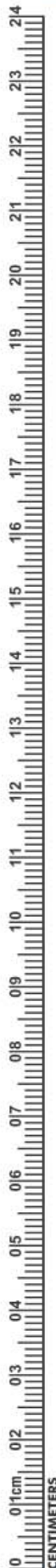

BALL SCALERS

CRANE-KAPLAN

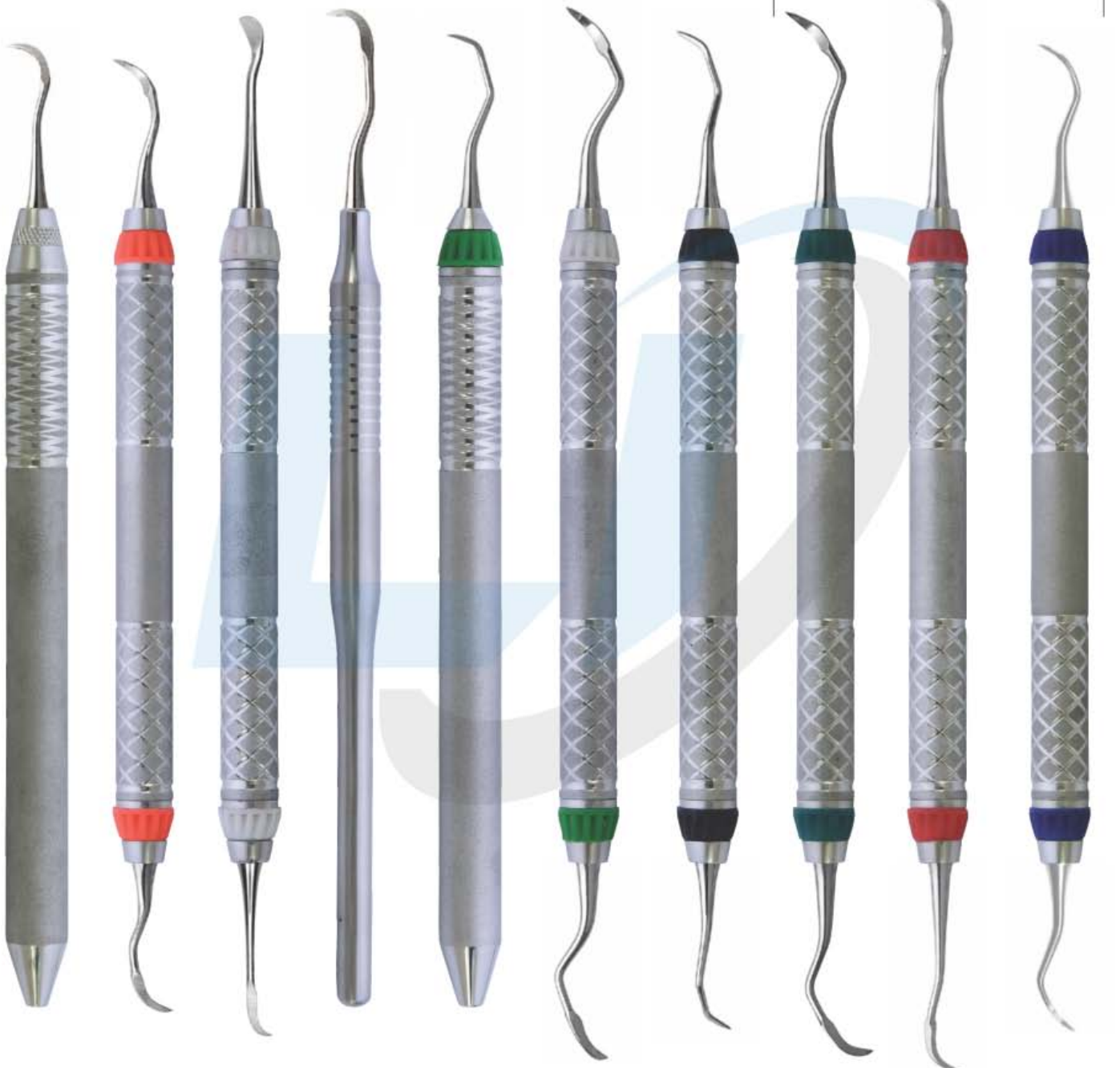

D1-039
CI-1

D1-040
CI-2/3

D1-041
152
Cumine

D1-042
B-1

D1-043
B-4

D1-044
B-2/3

D1-045
B-5/6

D1-046
CK-6

D1-047
CK-6D

D1-048
333/334
Mini Kaplan

CURETTES



- Кюрети
- Curetas
- Küretten
- Кюрети
- Curette
- کرتس

SCALER / CURETTE SETS

Mc CALL SET

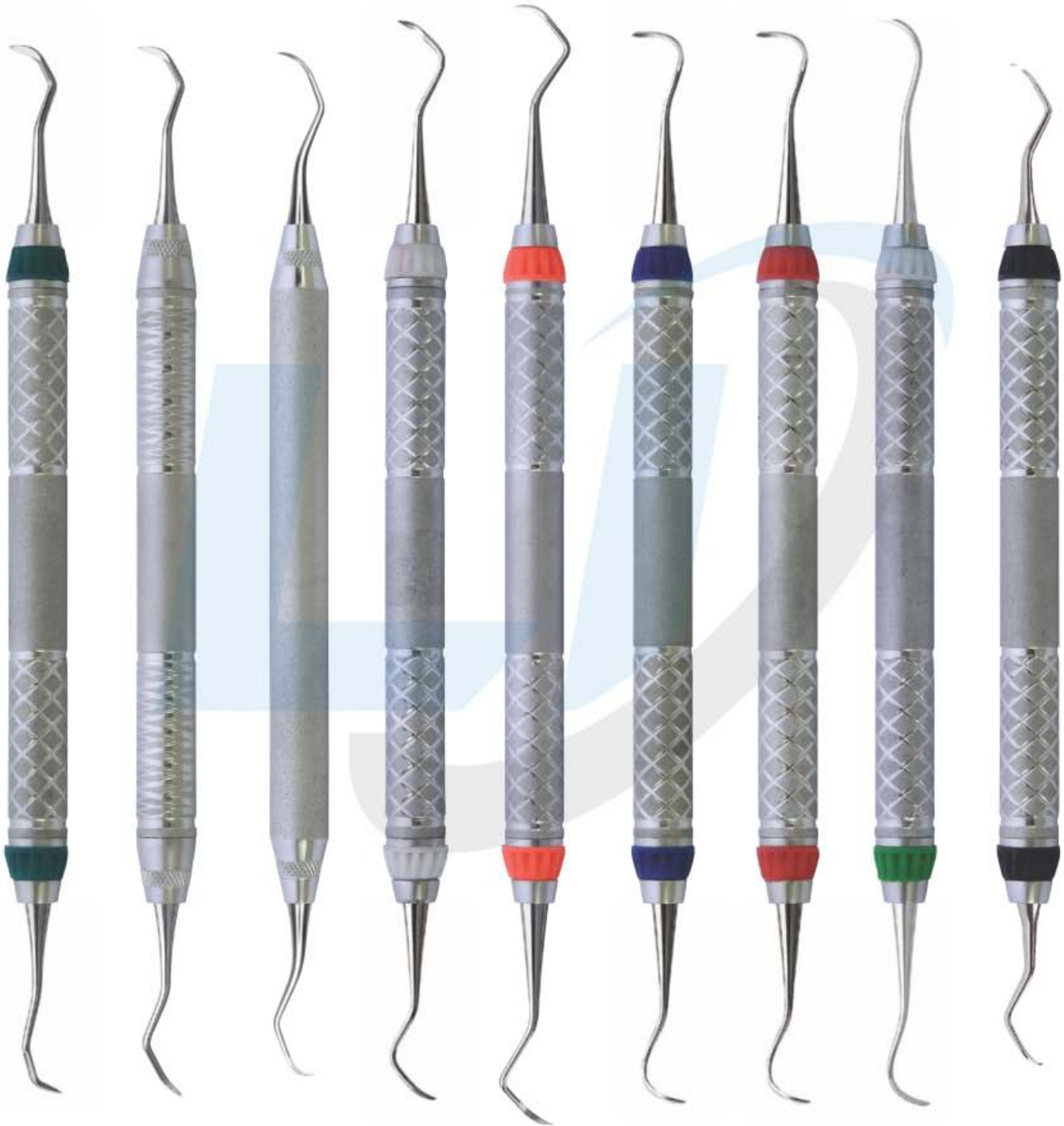

D1-049
11/12
Scaler

D1-050
11A/12A
Scaler

D1-051
11/12S
Modified
McCall

D1-052
13S/14S
Pointed
Curette

D1-053
MTC 13/14
Pointed
Curette

D1-054
17/18
Curette

D1-055
17S/18PT
Curette

D1-056
19/20
Curette

D1-057
Goldman-Fox



CURETTES

- Кюрети
- Curetas
- Kuretten
- Кюрети
- Curette
- کرتس

SCALER / CURETTE SETS

GOLDMAN-FOX SET

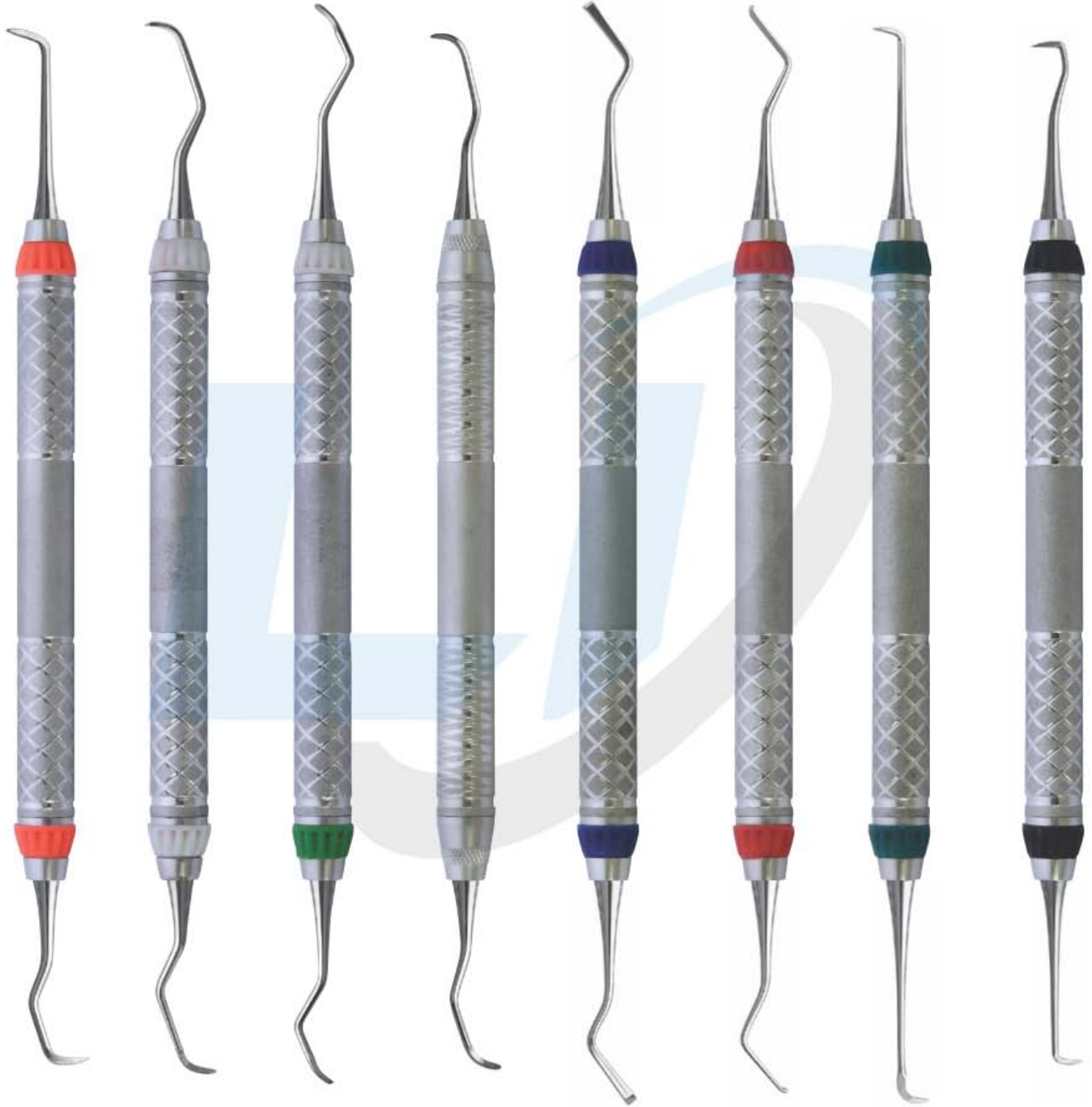

D1-058 GF-1 Universal Scaler	D1-059 GF-2 Curette	D1-060 GF-3 Curette	D1-061 GF-4 Curette	D1-062 GF-5 Hoe Buccal/Lingual	D1-063 GF-6 Hoe	D1-064 GF-21	D1-065 GF-21S/33 Combination
---	----------------------------------	----------------------------------	----------------------------------	---	------------------------------	------------------------	---

CURETTES



- Кюрети
- Curetas
- Küretten
- Кюрети
- Curette
- کرتس

SCALER / CURETTE SETS GOLDMAN-FOX SET

CATTONI SET

COLUMBIA

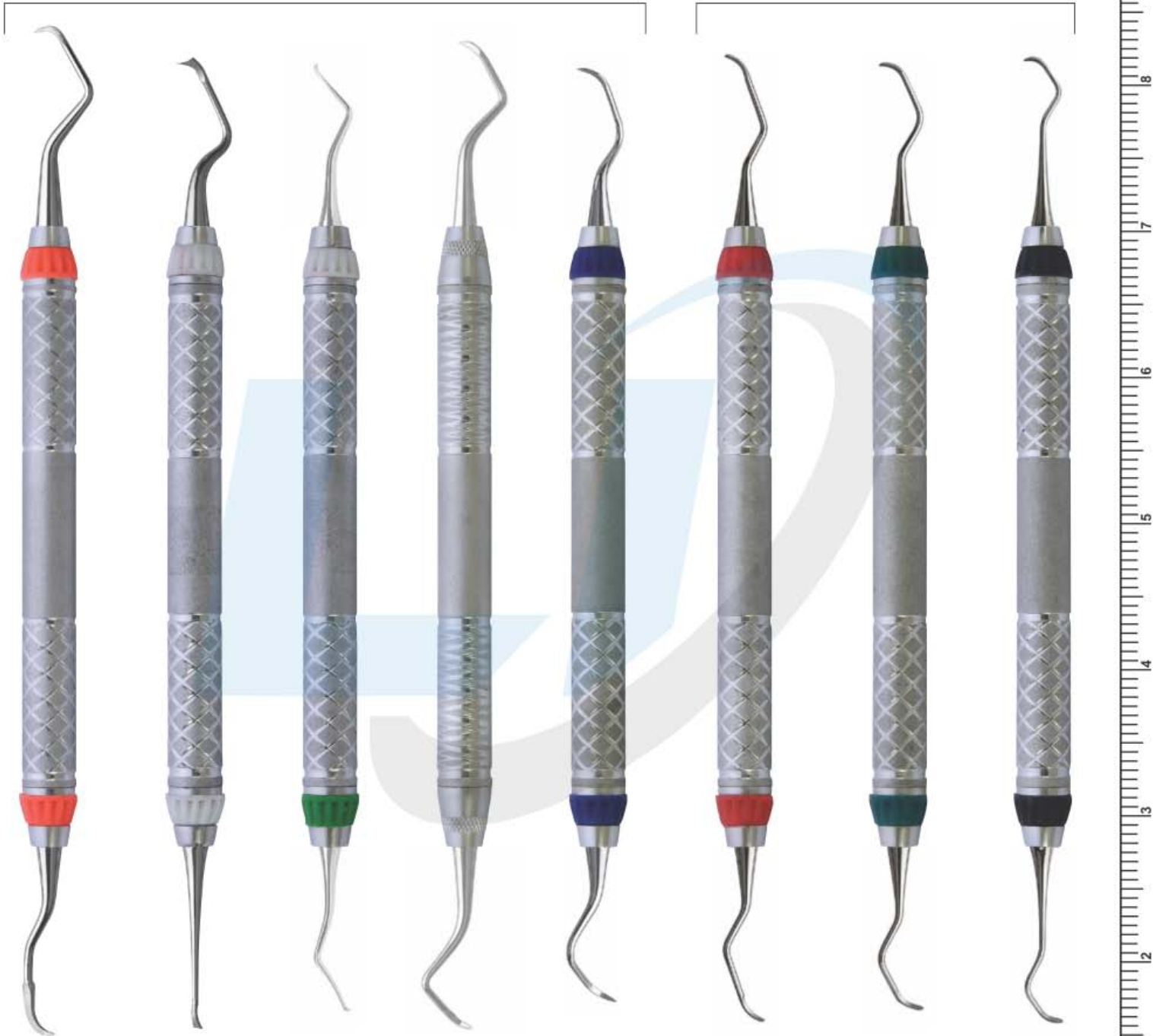

D1-066
103/106

D1-067
104/105
Hoe/Chisel

D1-068
112/113

D1-069
107/108

D1-070
107/108S
Modified

D1-071
2R/2L
Columbia

D1-072
4R/4L
Columbia

D1-073
13/14
Columbia (shown)

D1-074
13/14
Columbia Rigid

D1-075
13/14
Columbia
Curved Tip



CURETTES

- Кюрети
- Curetas
- Küretten
- Кюрети
- Curette
- كرتس

UNIVERSAL CURETTES

BARNHART

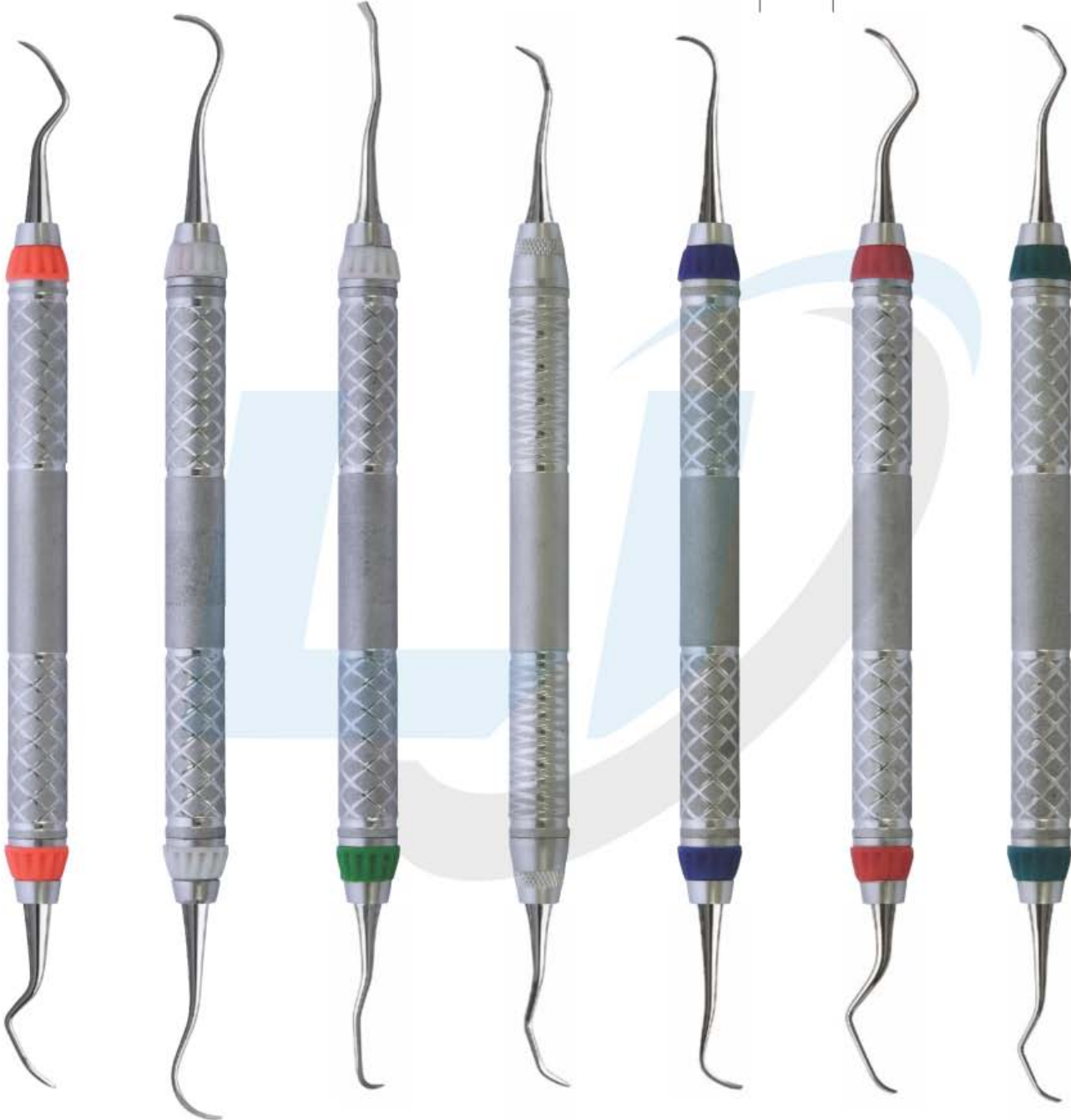
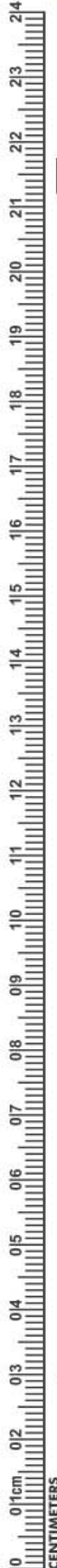

D1-076
IU13/14 Indiana University Anterior

D1-077
IU17/18 Indiana University Posterior

D1-078
1/2 Bunting Curette-Chisel combination

D1-079
5/6 Bunting

D1-080
YG7/8 Younger-Good

D1-081
1/2 Barnhart (shown)

D1-082
1/2 Barnhart Rigid

D1-083
5/6 Barnhart (shown)

D1-084
5/6 Barnhart Rigid

CURETTES



- Кюрети
- Curetas
- Küretten
- Кюрети
- Curette
- کرتس



D1-085 1/2 (shown) D1-086 1/2 Rigid



D1-087 3/4 (shown) D1-088 3/4 Rigid



D1-089 5/6 (shown) D1-090 5/6 Rigid

D1-091 5/6 Extra Rigid



D1-092 7/8 (shown) D1-093 7/8 Rigid

D1-094 7/8 Extra Rigid



GRACEY 1/2



GRACEY 7/8



GRACEY 11/12



GRACEY 13/14



GRACEY 15/16



GRACEY 17/18



D1-095 9/10 (shown) D1-096 9/10 Rigid



D1-097 11/12 (shown) D1-098 11/12 Rigid

D1-099 11/12 Extra Rigid



D1-100 13/14 (shown) D1-101 13/14 Rigid

D1-102 13/14 Extra Rigid



D1-103 15/16 (shown) D1-104 15/16 Rigid



D1-105 17/18 (shown) D1-106 17/18 Rigid



- Кюрети
- Curetas
- Küretten
- Кюрети
- Curette
- کرتس

GRACEY CURETTES

MICRO MINI

GRACEY PROPHY CURETTES



D1-107
Micro Mini
Five 1/2

D1-108
Micro Mini
Five 7/8

D1-109
Micro Mini
Five 11/12

D1-110
Micro Mini
Five 13/14

D1-111
P1/2

D1-112
P3/4

D1-113
P5/6

D1-114
P7/8



EXPLORERS



- Зонды
- Sondes
- Zahnsonden
- Зонди
- Sondas
- المستكشفين

WILLIAM PROBE SET DOUBLE ENDED WITH HOLLOW HANDLE 9.5MM, LENGTH 170MM
CERAMIC COATED HANDLE

Proper care must be given during cleaning, sharpening and sterilization to preserve design and integrity and to prolong usefulness. Do not expose instruments to sterilization temperatures above 350 F/177 C or to higher than recommended chemical concentrations.

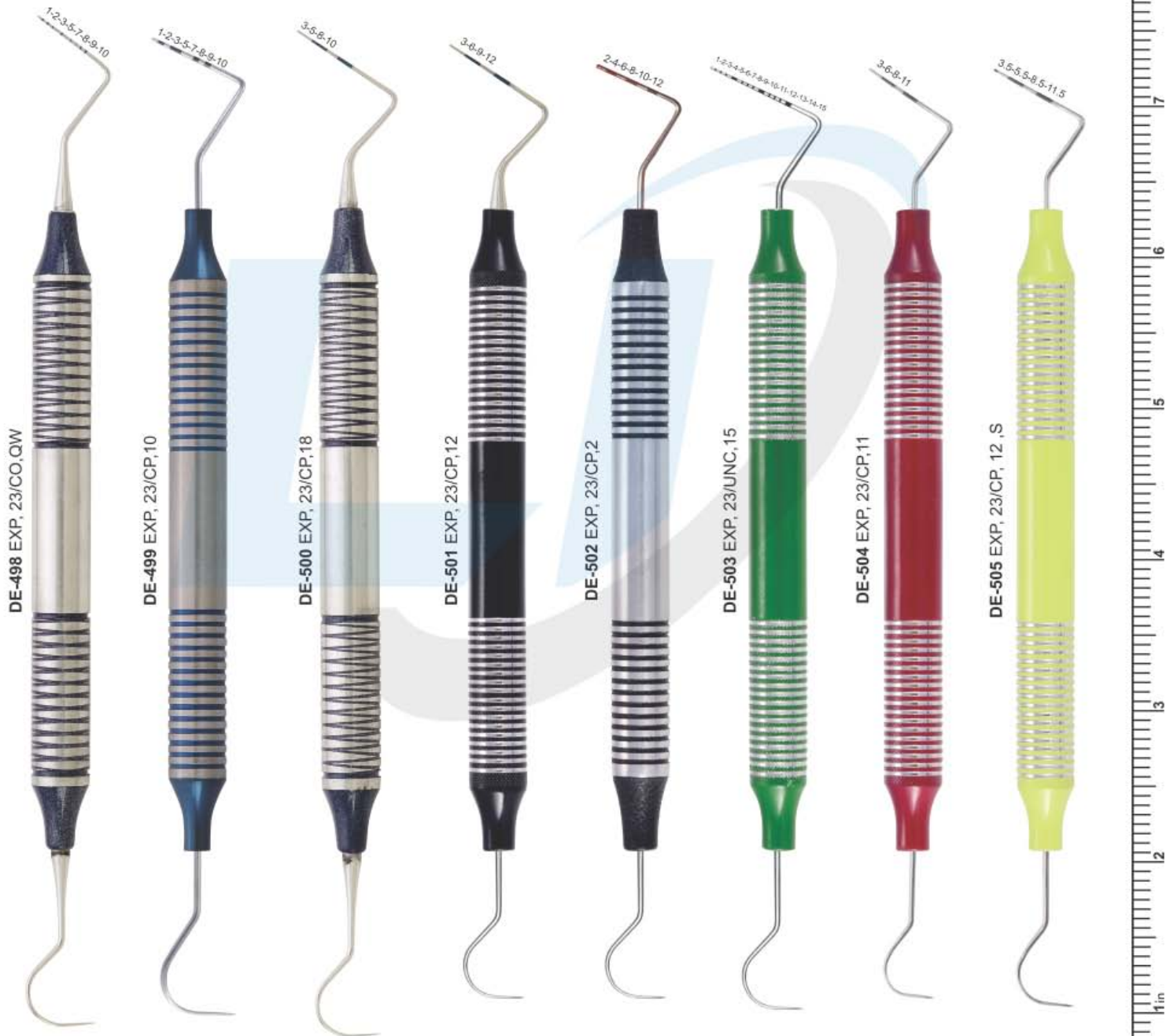

- Инструменты пародонтологические
- Instruments pour la parodontologie
- Instrumente für die Parodontologie

- Інструменти пародонтологічні
- instrumentos para periodoncia
- الصكوك اللثة

**PERIODONTAL INSTRUMENTS SET OF 11 PCS
SOLID HANDLE 6MM, LENGTH 170MM**

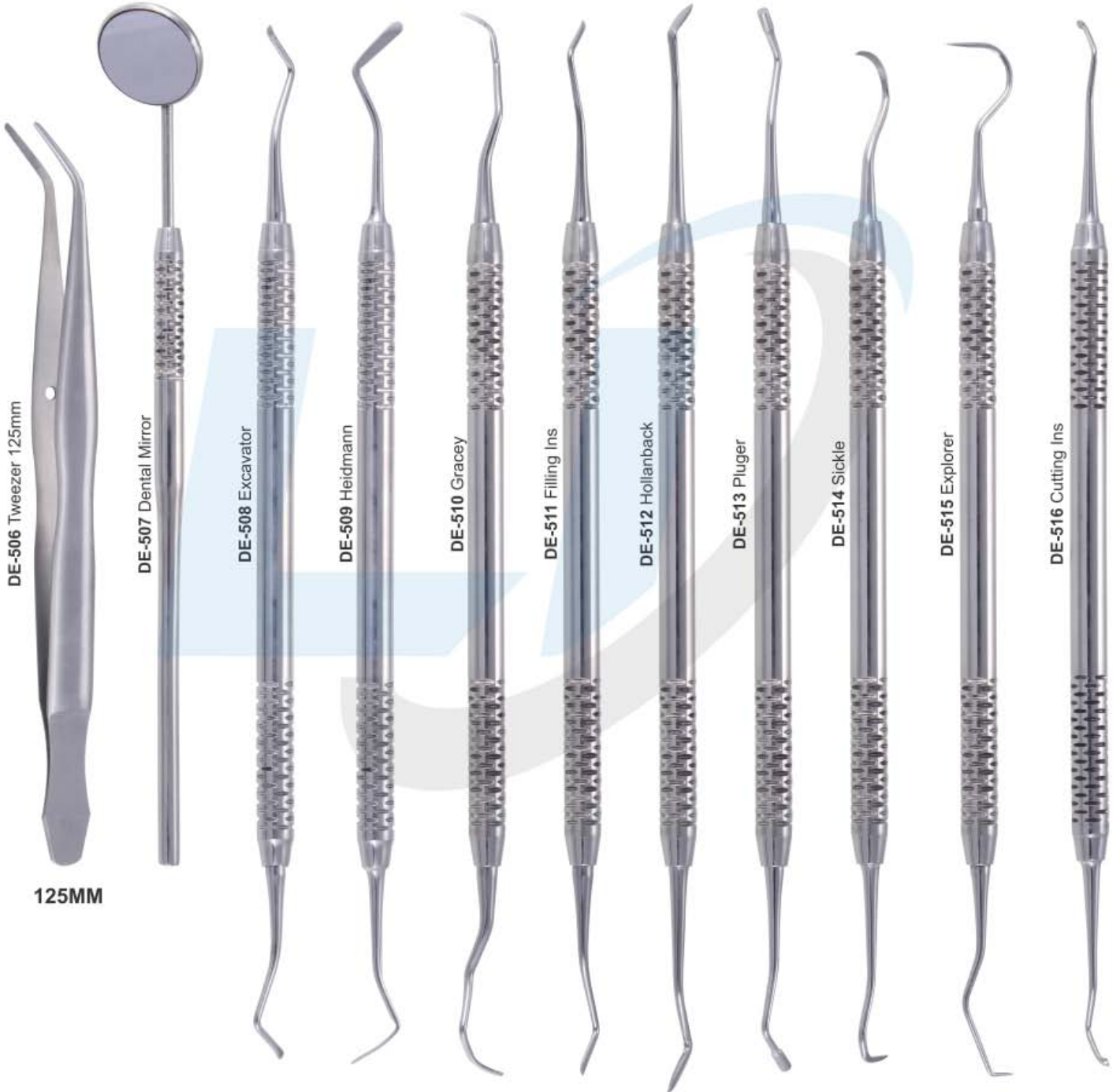
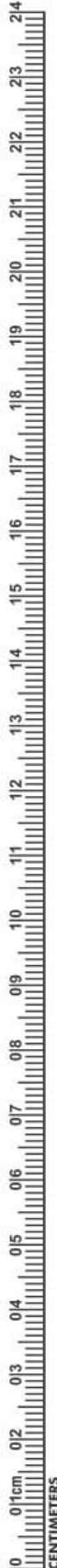

DE-506 Tweezer 125mm

DE-507 Dental Mirror

DE-508 Excavator

DE-509 Heidmann

DE-510 Gracey

DE-511 Filling Ins

DE-512 Hollanback

DE-513 Plugger

DE-514 Sickle

DE-515 Explorer

DE-516 Cutting Ins

125MM

CURETTES



- Кюрети
- Curetas
- Küretten
- Кюрети
- Curette
- كرتس

GRACEY SET OF 7 PCS HOLLOW HANDLE 9.5MM, LENGTH 170MM



DE-517
GRACEY
1/2

DE-518
GRACEY
3/4

DE-519
GRACEY
5/6

DE-520
GRACEY
7/8

DE-521
GRACEY
9/10

DE-522
GRACEY
11/12

DE-523
GRACEY
13/14



CURETTES

- Кюрети
- Curetas
- Küretten
- Кюрети
- Curette
- كرتس

GRACEY SET OF 7 PCS HOLLOW HANDLE 9.5MM, LENGTH 170MM WITH SILICON GRIP



CURETTES



- Кюрети
- Curetas
- Küretten
- Кюрети
- Curette
- كرتس

GRACEY MINI FIVE

HOLLOW HANDLE 9.5MM, LENGTH 170MM
CERAMIC COATED HANDLE

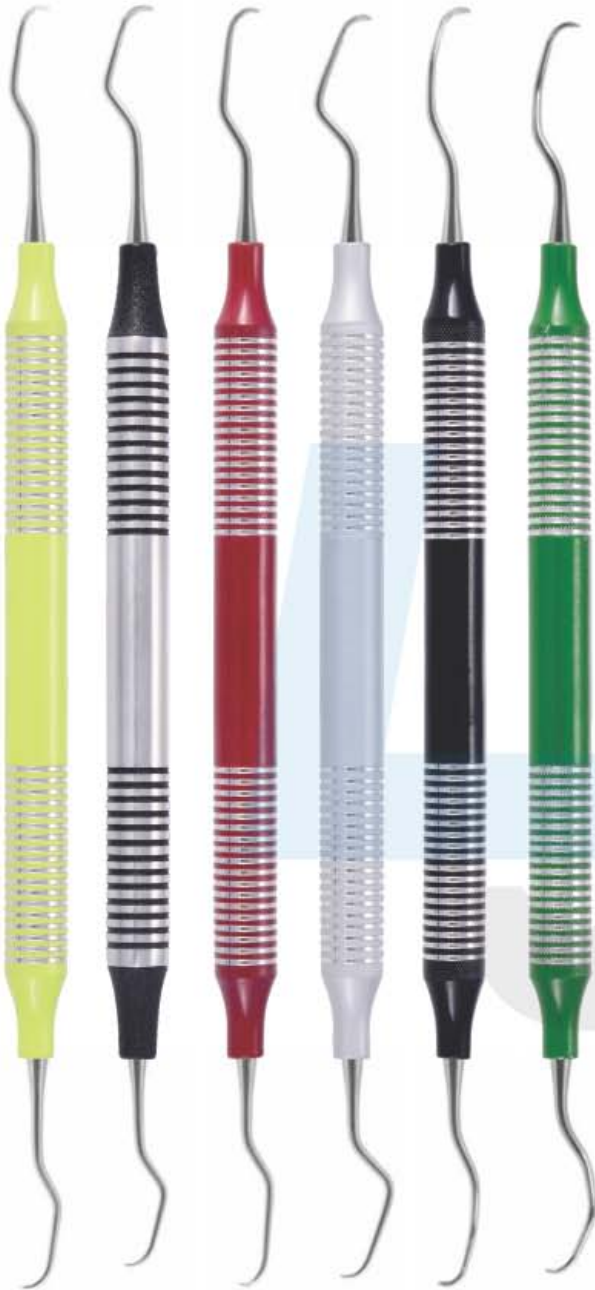

DE-531 Gracey 1/2
DE-532 Gracey 3/4
DE-533 Gracey 5/6
DE-534 Gracey 7/8
DE-535 Gracey 11/12
DE-536 Gracey 13/14

GRACEY AFTER FIVE

HOLLOW HANDLE 9.5MM, LENGTH 170MM
CERAMIC COATED HANDLE

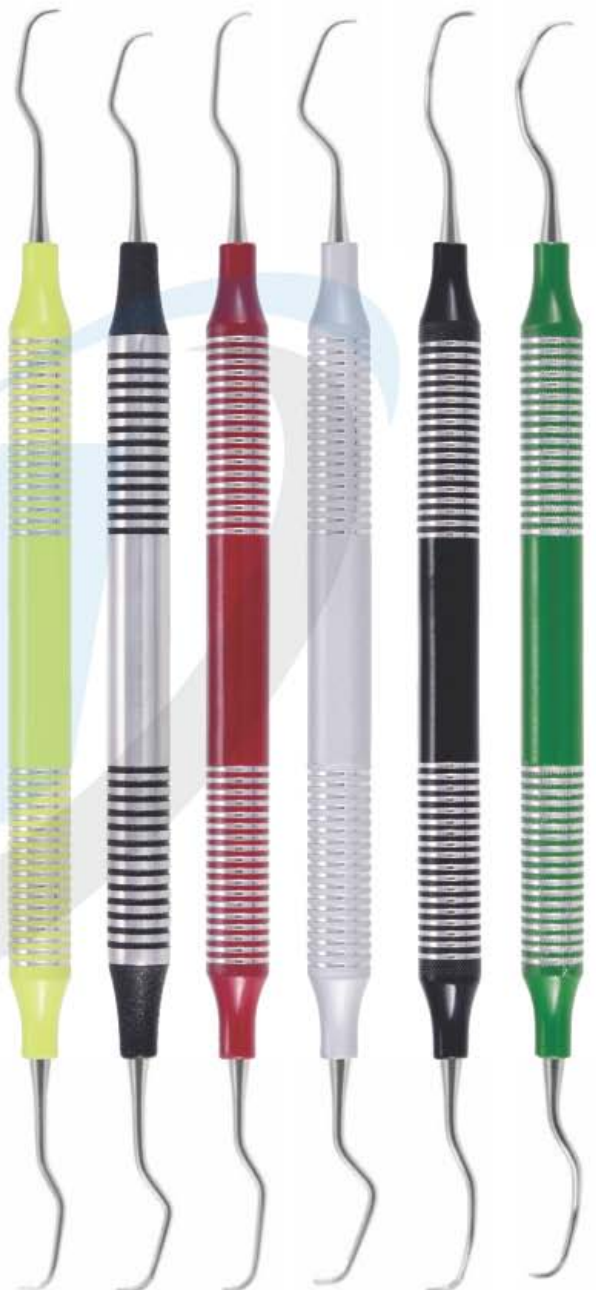

DE-537 Gracey 1/2 AF
DE-538 Gracey 3/4 AF
DE-539 Gracey 5/6 AF
DE-540 Gracey 7/8 AF
DE-541 Gracey 11/12 AF
DE-542 Gracey 13/14 AF

Proper care must be given during cleaning, sharpening and sterilization to preserve design and integrity and to prolong usefulness. Do not expose instruments to sterilization temperatures above 350 F/177 C or to higher than recommended chemical concentrations.



- Кюрети
 - Curetas
 - Kuretten
- Кюрети
 - Curette
 - کرتس

GRACEY CURETTE HOLLOW HANDLE 10MM, LENGTH 170MM

Curetters Set of 8 Pieces

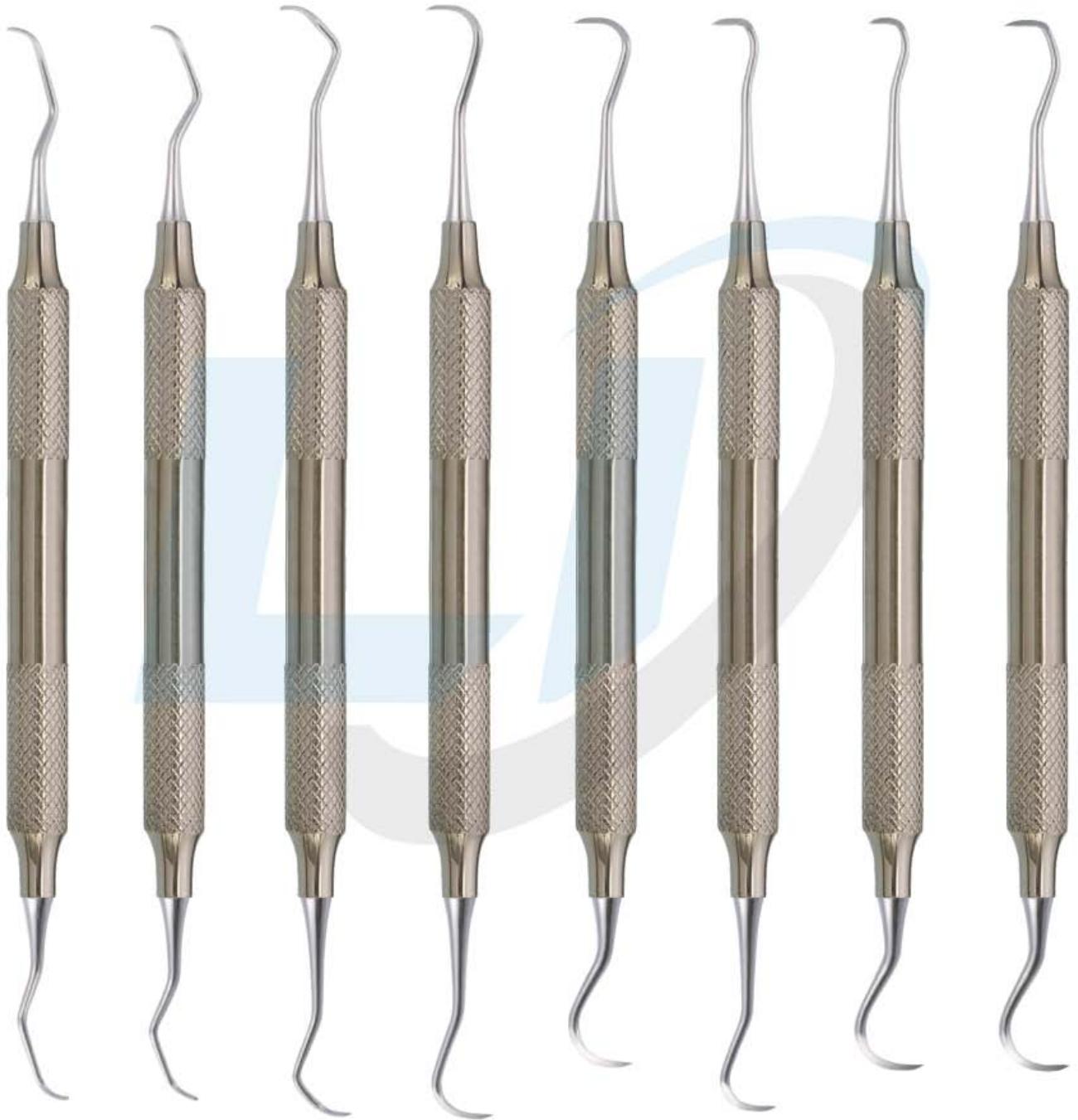

DE-543
Curette
Columbia
2L-2R

DE-544
Curette
Columbia
4L-4R

DE-545
Curette
McCall
13S-14S

DE-546
H6-H7
Scaler
Sickle

DE-547
H5-U15
Scaler
Sickle

DE-548
H5-13
Scaler
Sickle

DE-549
U15-30
Scaler
Sickle

DE-550
U15-33
Scaler
Sickle

FILLING INSTRUMENTS



- Инструменты для реставрации
- Instruments pour plombage
- Füllungsinstrumente (mit Kontrawinkel)
- Инструменти для реставрації
- Instrumentos para obturaciones
- ملء الصكوك

FILLING INSTRUMENTS (Gold Pointed)
SOLID HANDLE 6MM, LENGTH 170MM



Solid Handle Size 4.25"

Tip Size: 1/1

DE-551 1.5mm / 1.5mm

DE-552 2.0mm / 2.0mm

DE-553 2.0mm / 2.0mm

DE-554 2.5mm / 2.5mm

DE-555 1.3mm / 0.9mm

DE-556 1.6mm / 1.3mm

DE-557 2.4mm / 1.8mm

DE-558 2.4mm / 2.0mm

DE-559 1.3mm / 1.5mm

DE-560 1.8mm / 1.2mm

Filling instrument, spatula 6 mm solid handle, length 170 mm,

Filling instrument 6 mm length 175 mm,

Filling instrument, ball 6 mm length 170 mm,

Filling instrument, ball / spatula 6 mm length 175 mm,

Filling instrument, plan / plan 6 mm length 165 mm,



EXPLORERS

EXPLORERS INSTRUMENTS SOLID HANDLE 6MM, LENGTH 170MM

- Зонды
 - Sondes
 - Zahnsonden
- Зонди
 - Sondas
 - المستكشفين



PLUGGERS

 DE-561 1/3 21mm	 DE-562 5/7 21mm	 DE-563 9/11 21mm	 DE-564 1/2 Root Canal Plugger	 DE-565 3/4 Root Canal Plugger
 DE-568 ISO Size 30 24mm	 DE-569 ISO Size 40 24mm	 DE-570 ISO Size 50 24mm	 DE-566 MA57 27mm	 DE-567 GP3 30mm
 DE-571 ISO Size 60 24mm				

PERIODONTAL PROBES



- Зонды пародонтологические
- Sondes paradontales
- sonda paradontali
- зонди пародонтологічні
- Sondas paradontales
- المسابر اللثة

SPREADERS

HEAT CARRIERS

Tip Size: 1/1

Solid Handle Size 4, 25"

Model	Tip Size	ISO / Other	Length
DE-572	.30	ISO Size 30	24mm
DE-573	.40	ISO Size 40	24mm
DE-574	.50	ISO Size 50	28mm
DE-575	.60	ISO Size 60	28mm
DE-576	.25	GP1	20mm
DE-577	.30	1S Wakai	22mm
DE-578	.40	2S Wakai	22mm
DE-579	.40	D11 Standard	23mm
DE-580	.35	D11S Thin	23mm
DE-581	.23	D11T Thinner	22mm
DE-582	.20	D11TS Thinnest	21mm
DE-583	.35	3	28mm
DE-584	.25	GP2	25mm
DE-585	.35	0‡	25mm
DE-586	.55	00‡	25mm

HEAT CARRIERS



- Зонды пародонтологические
- Sondes parodontales
- sonda parodontali
- зонди пародонтологічні
- Sondas parodontales
- المسابر اللثة

ENDODONTICS INSTRUMENTS

ANTERIOR

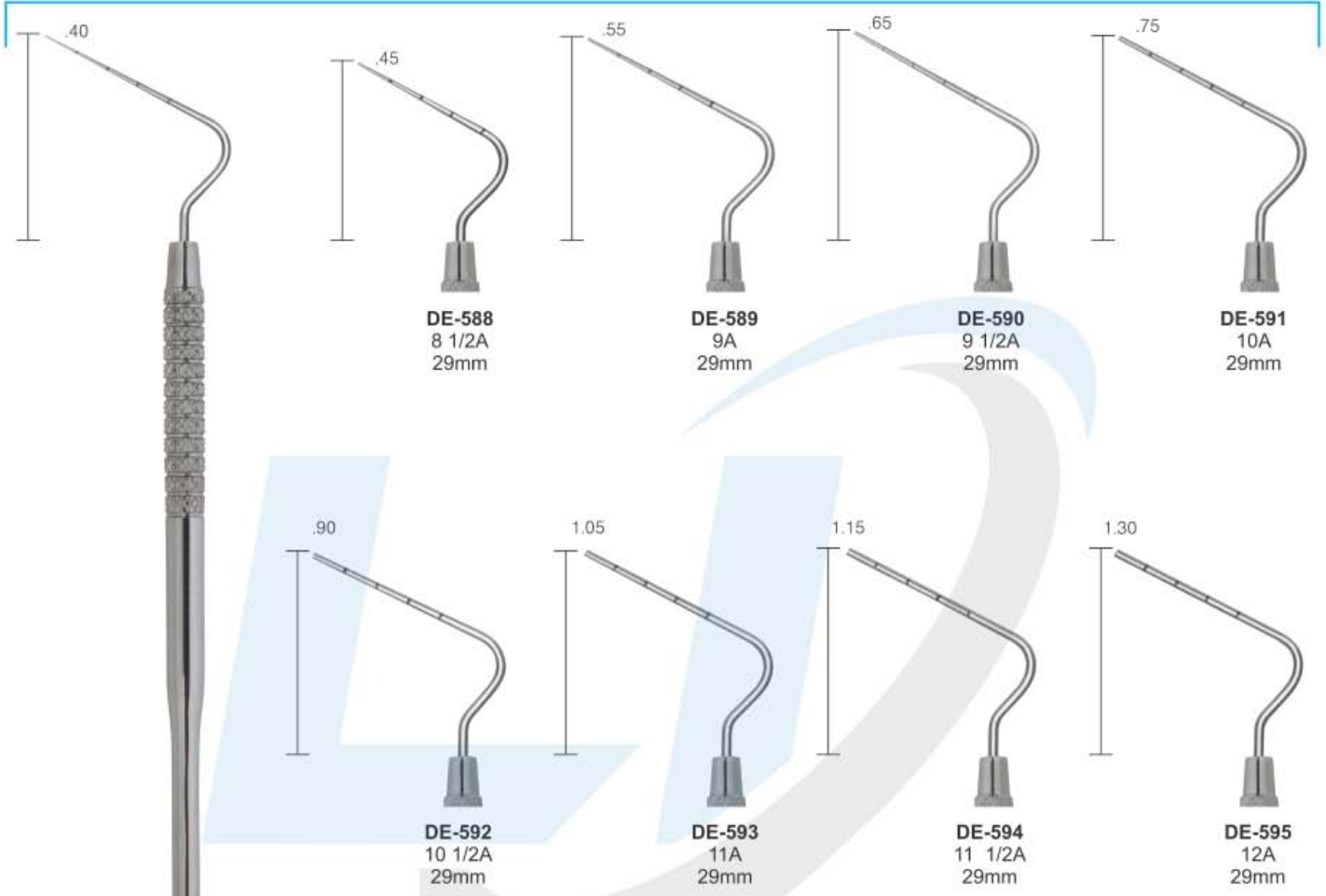

LUKS



PERIODONTAL PROBES



- Зонды пародонтологические
- Sondes parodontales
- sonda parodontali
- зонди пародонтологічні
- Sondas parodontales
- المسابر اللثة

ENDODONTICS INSTRUMENTS SOLID HANDLE 6MM, LENGTH 170MM

POSTERIOR

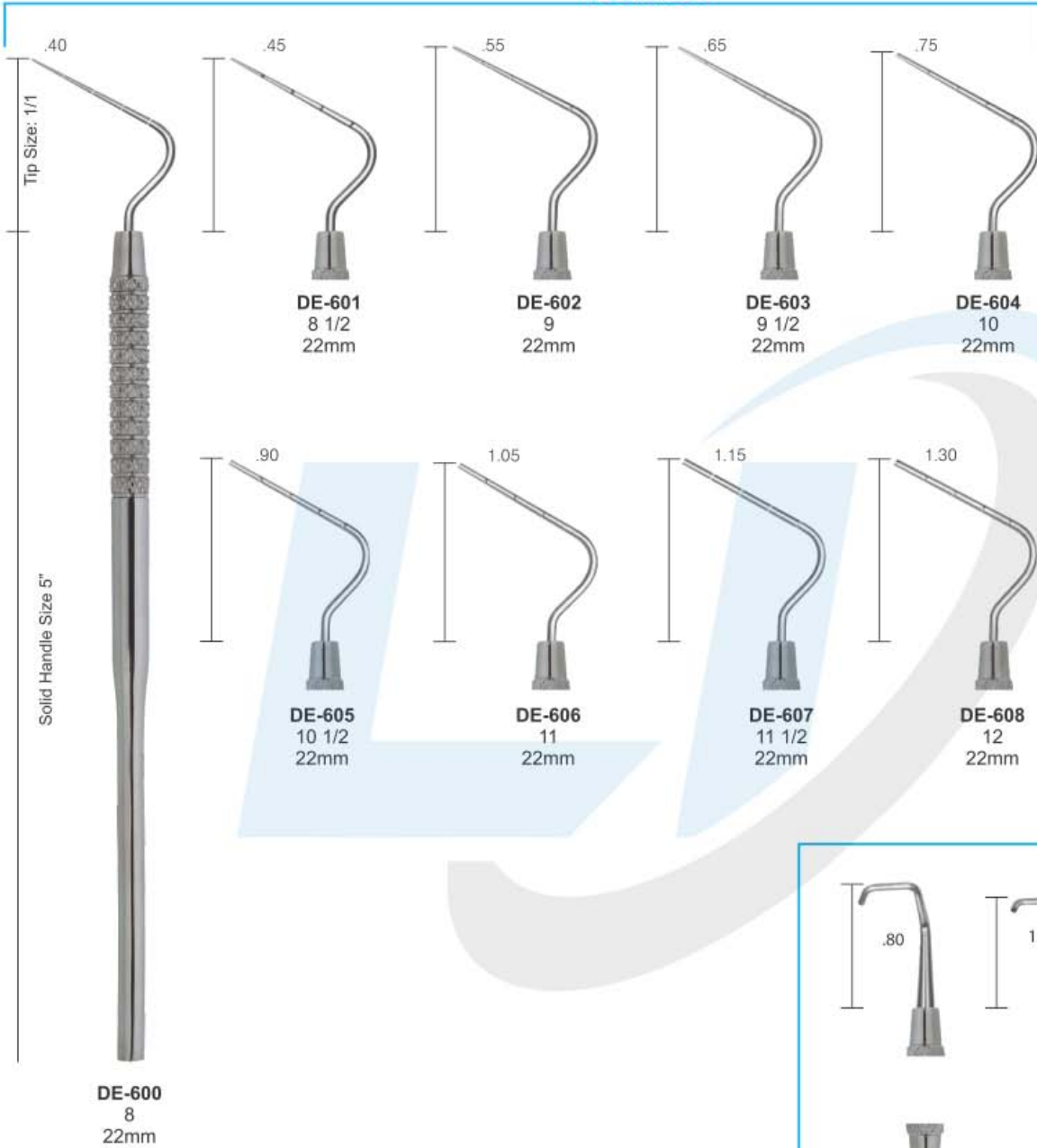

RETRO FILLING PLUGGERS

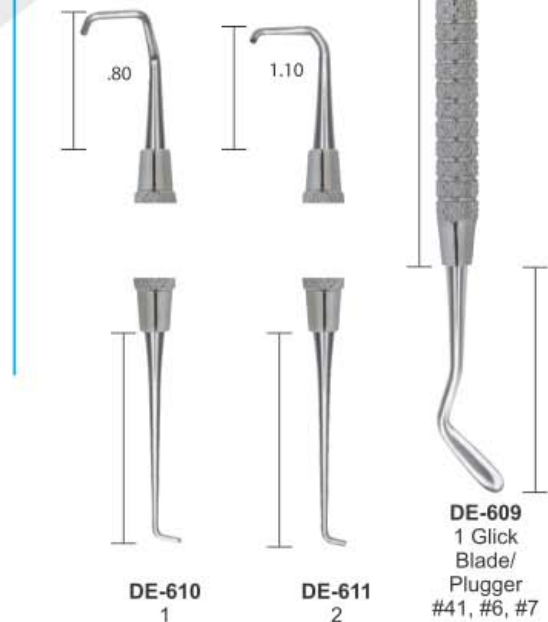

- Инструменты для реставрации
- Instruments pour plombage
- Füllungsinstrumente (mit Kontrawinkel)

- Инструменти для реставрації
- Instrumentos para obturaciones
- ملء الصكوك

COMPOSITE/PLASTIC FILLING INSTRUMENTS SOLID HANDLE 6MM, LENGTH 170MM

POSTERIOR

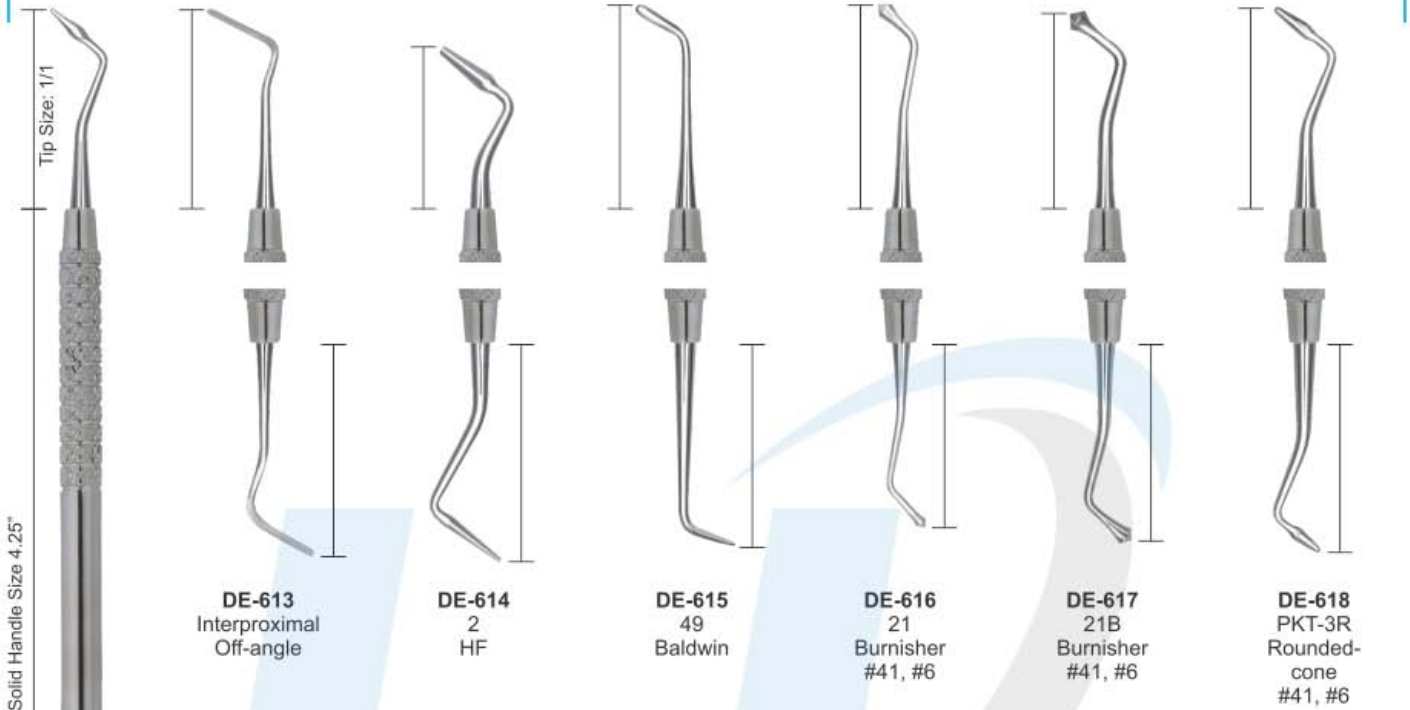

UNIVERSAL FILLING INSTRUMENTS

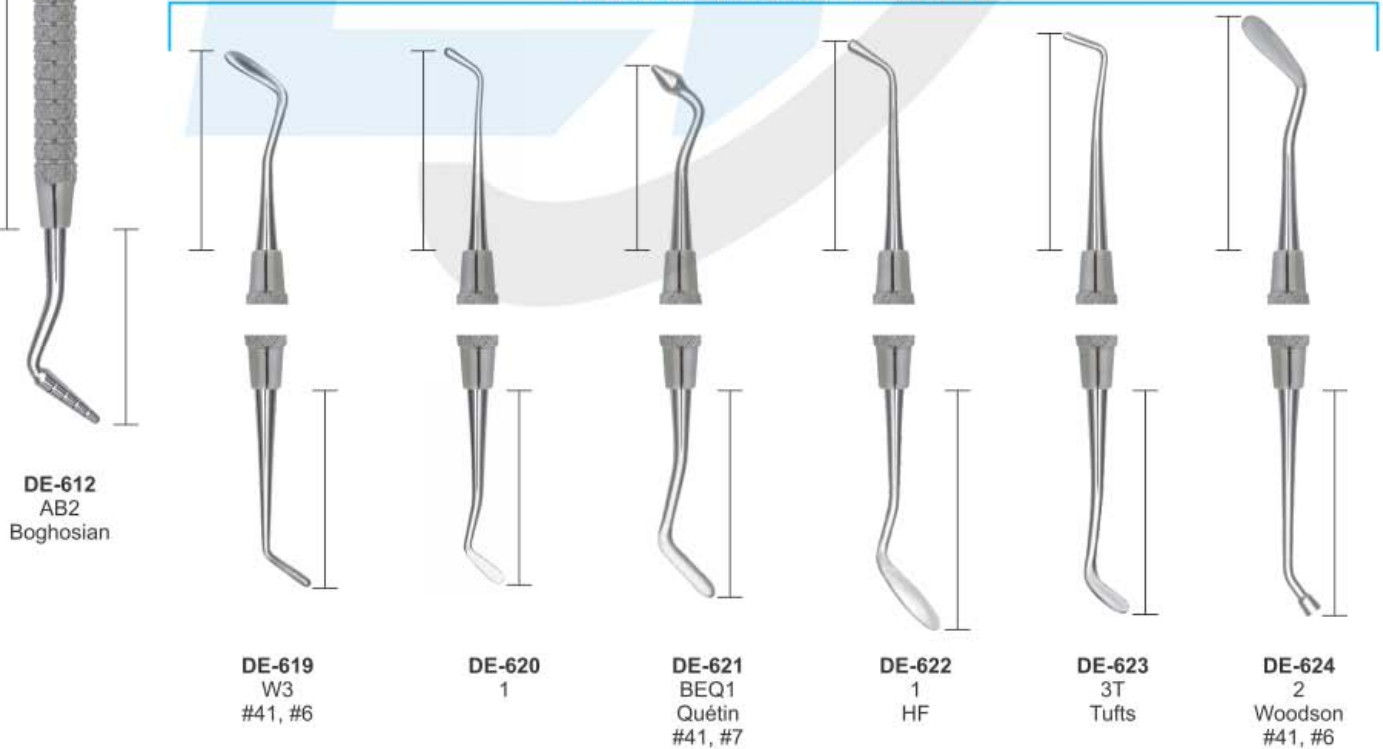

FILLING INSTRUMENTS



- Инструменты для реставрации
- Instruments pour plombage
- Füllungsinstrumente (mit Kontrawinkel)
- Инструменти для реставрації
- Instrumentos para obturaciones
- ملء الصكوك

COMPOSITE/PLASTIC FILLING INSTRUMENTS SOLID HANDLE 6MM, LENGTH 170MM

BLACK

PLUGGERS/CONDENSERS

Hollenback

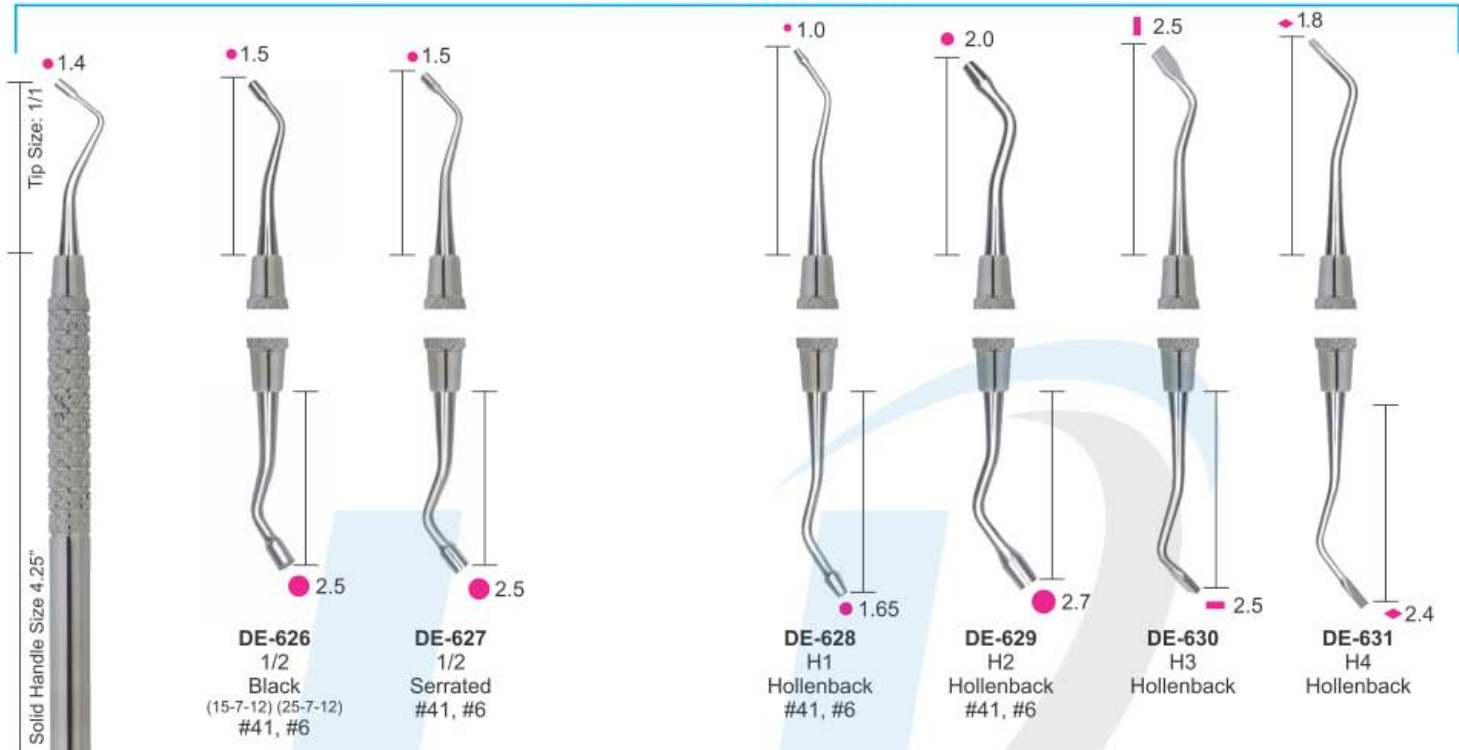

MARQUETTE CONDENSER

MORTONSON

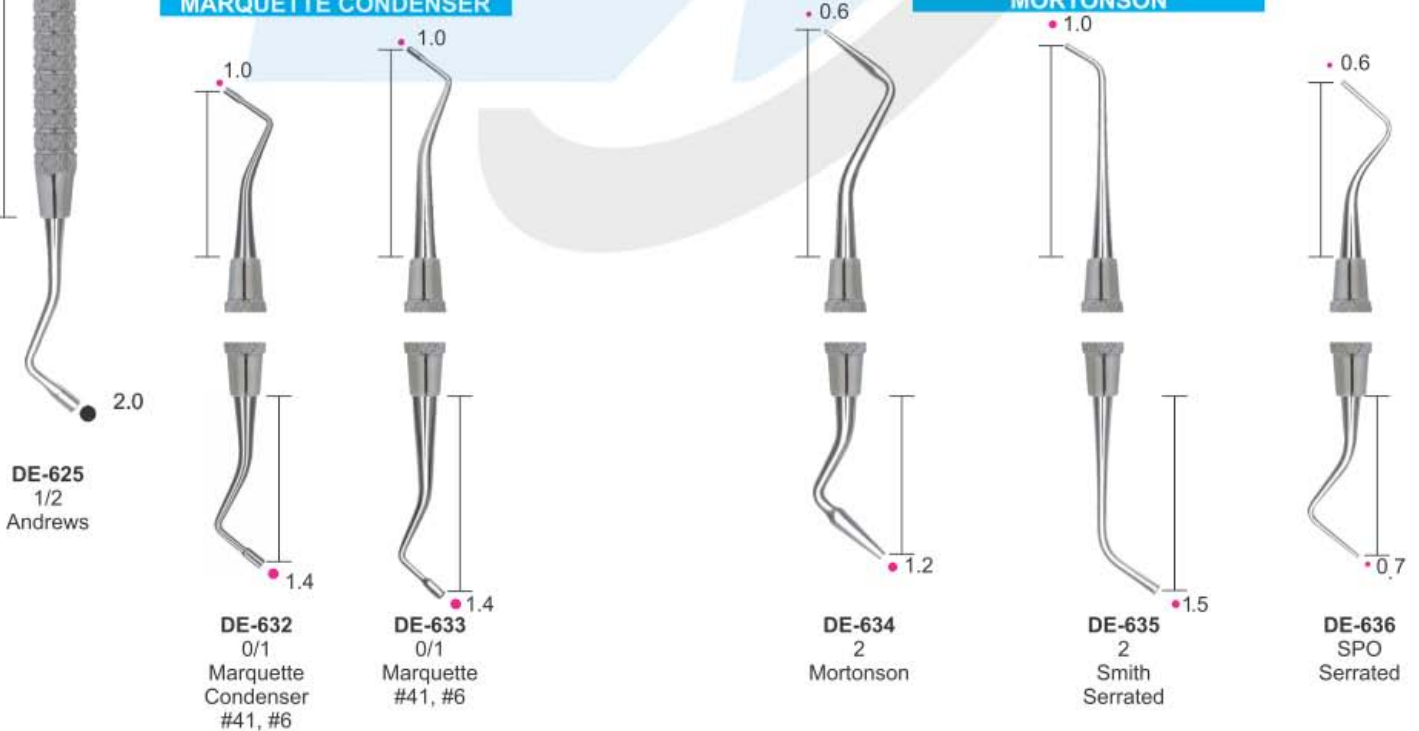

- Инструменты для реставрации
- Instruments pour plomage
- Füllungsinstrumente (mit Kontrawinkel)

- Інструменти для реставрації
- Instrumentos para obturaciones
- ملء الصكوك

PLUGGERS/CONDENSERS

RESTORATIVE INSTRUMENTS SOLID HANDLE 6MM, LENGTH 170MM



PLUGGERS/CONDENSERS



FILLING INSTRUMENTS



- Инструменты для реставрации
- Instruments pour plombage
- Füllungsinstrumente (mit Kontrawinkel)

- Інструменти для реставрації
- Instrumentos para obturaciones
- ملء الصكوك

RESTORATIVE INSTRUMENTS SOLID HANDLE 6MM, LENGTH 170MM Back Action Filling Instruments

Tanner Filling Instruments

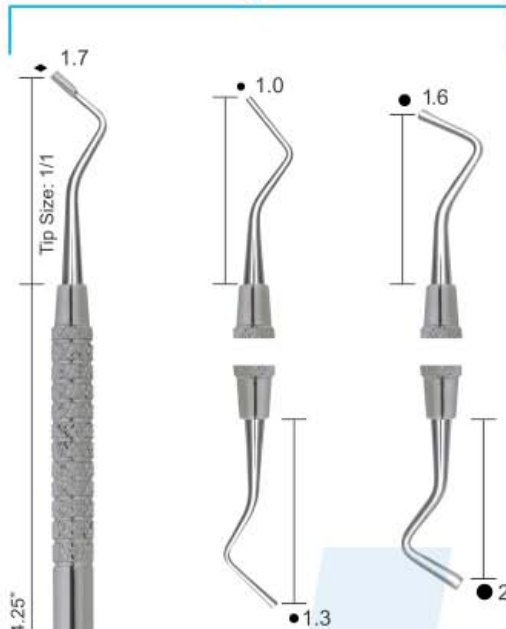

DE-649
2T
Tanner

DE-650
3T
Tanner

DE-651
9/10
Back Action

DE-652
11/12
Back Action

DE-653
153
English Pattern
Serrated

DE-654
153
English Pattern
Serrated

BALL

BURNISHERS

BEAVERTAIL

ACORN

LADMORE

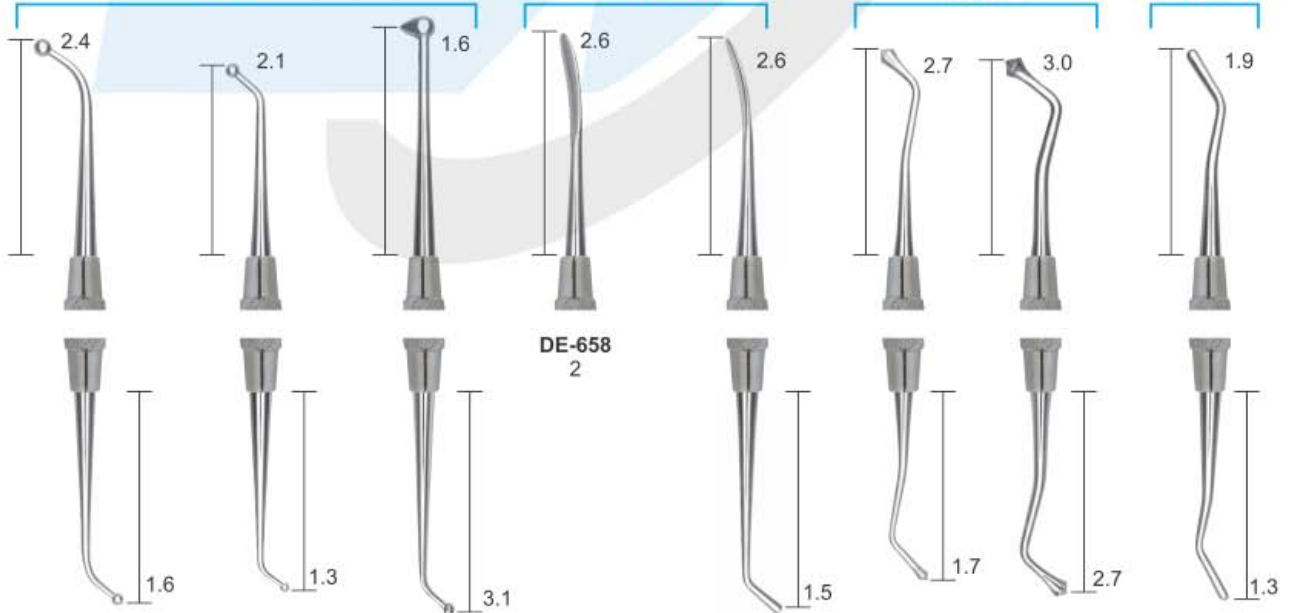

DE-648
1T
Tanner

DE-655
18
#41, #6

DE-656
26/27S
#41, #6

DE-657
27/29
#41, #6, #7, #8

DE-658
2

DE-659
2
Double-End

DE-660
21
#41, #6

DE-661
21B
#41, #6, #8

DE-662
2
Ladmore



- Инструменты для реставрации
- Instruments pour plombage
- Füllungsinstrumente (mit Kontrawinkel)

- Інструменти для реставрації
- Instrumentos para obturaciones
- ملء الصكوك

RESTORATIVE INSTRUMENTS SOLID HANDLE 6MM, LENGTH 170MM

BURNISHERS

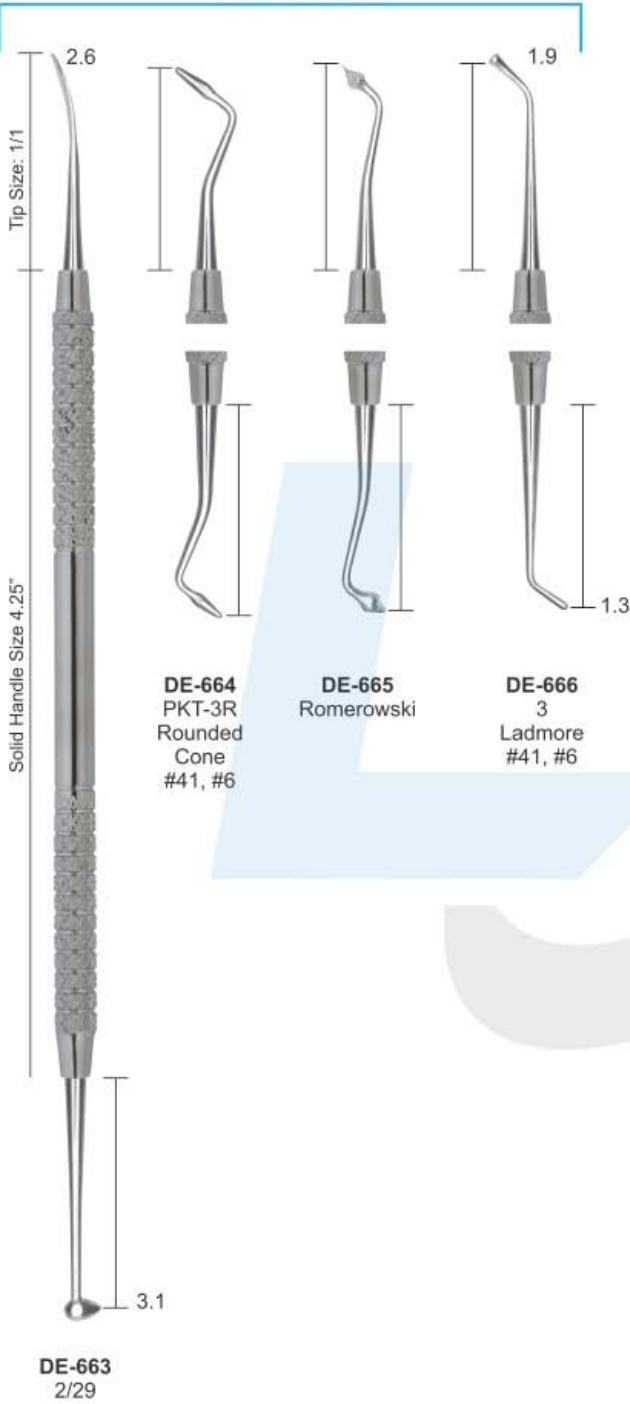

PERIODONTAL FILES

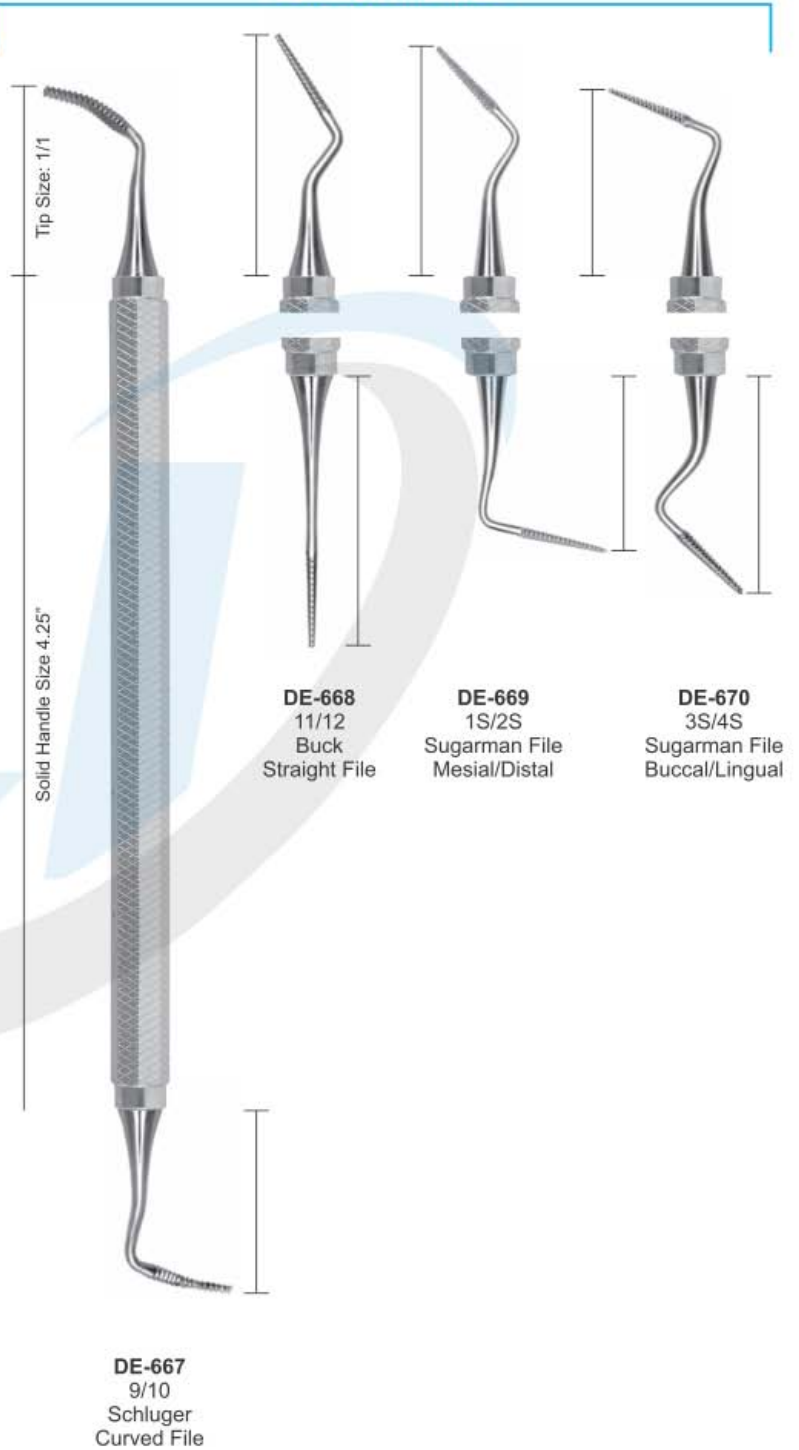

FILLING INSTRUMENTS



- Инструменты для реставрации
- Instruments pour plombage
- Füllungsinstrumente (mit Kontrawinkel)
- Инструменти для реставрації
- Instrumentos para obturaciones
- ملء الصكوك

COMPOSITE/PLASTIC FILLING INSTRUMENTS SOLID HANDLE 6MM, LENGTH 170MM

BURNISHER FILLING INSTRUMENTS

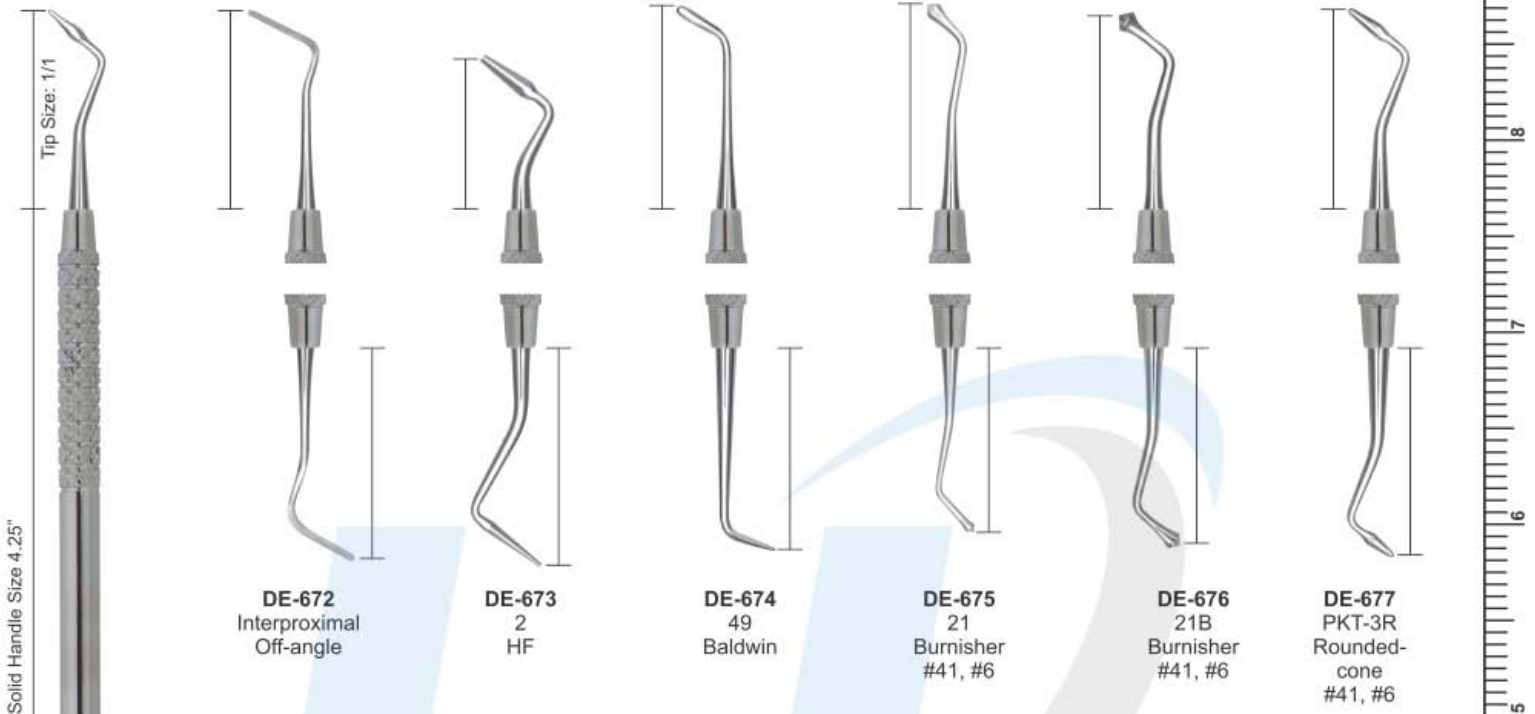

UNIVERSAL FILLING INSTRUMENTS

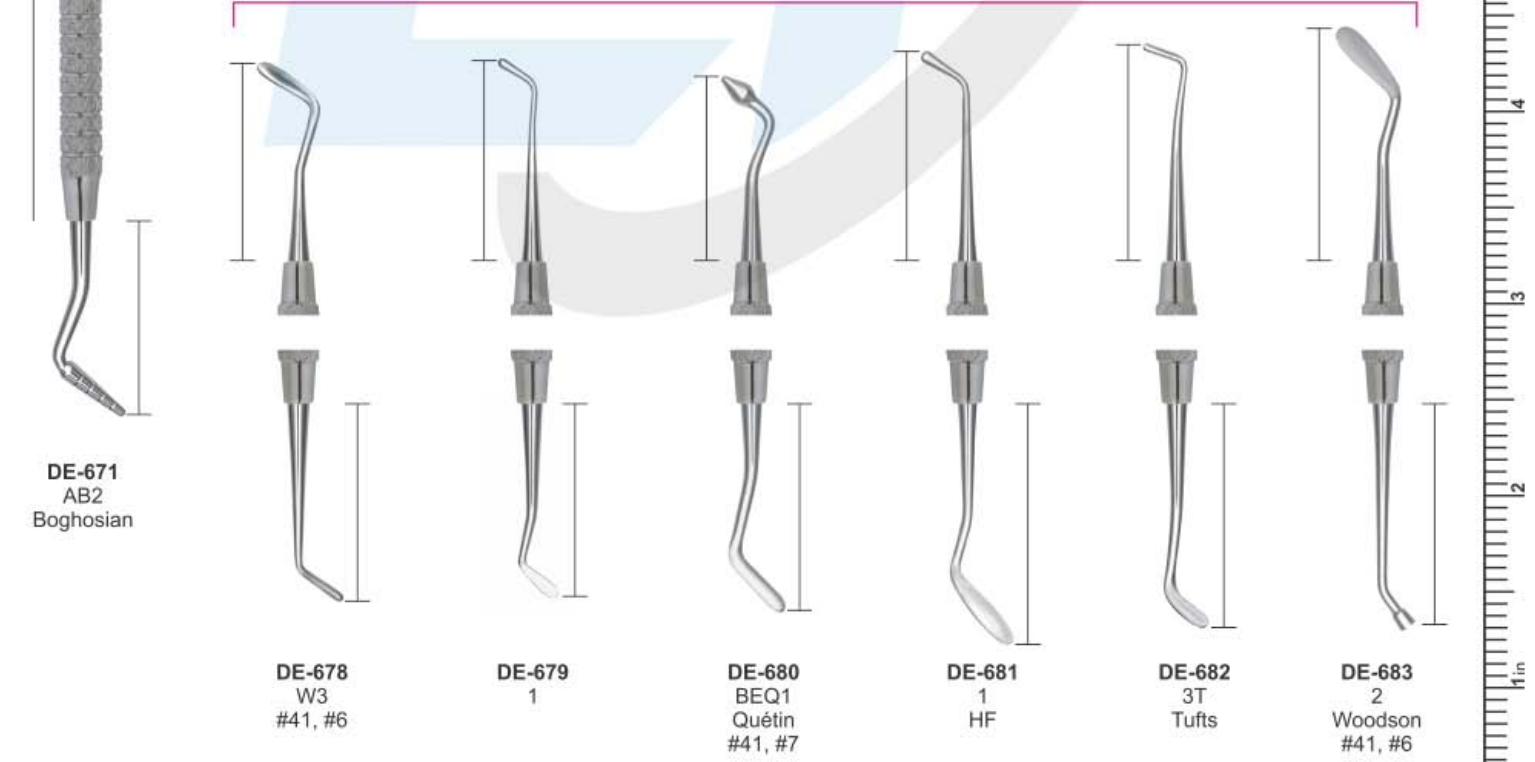

- Инструменты для реставрации
- Instruments pour plombage
- Füllungsinstrumente (mit Kontrawinkel)

- Інструменти для реставрації
- Instrumentos para obturaciones
- ملء الصكوك

FILLING INSTRUMENTS SOLID HANDLE 6MM, LENGTH 170MM

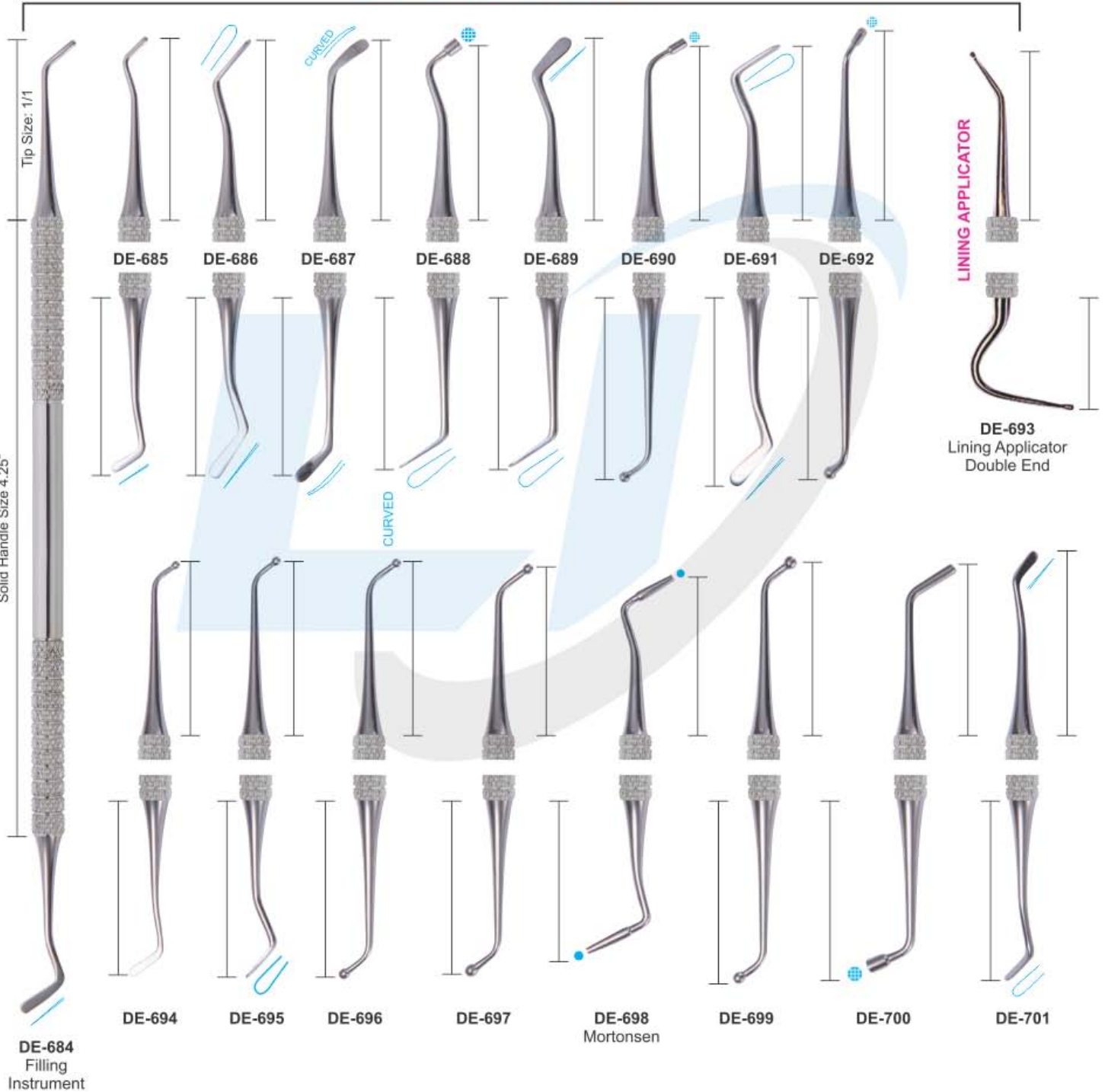

AMALGAM CARVERS



- Инструменты для реставрации
- Instruments pour amalgame
- Amalgampistolen
- Инструменти для реставрації
- instrumentos para amalgama
- تطعيج المنغفم

AMALGAM INSTRUMENTS SOLID HANDLE 6MM, LENGTH 170MM

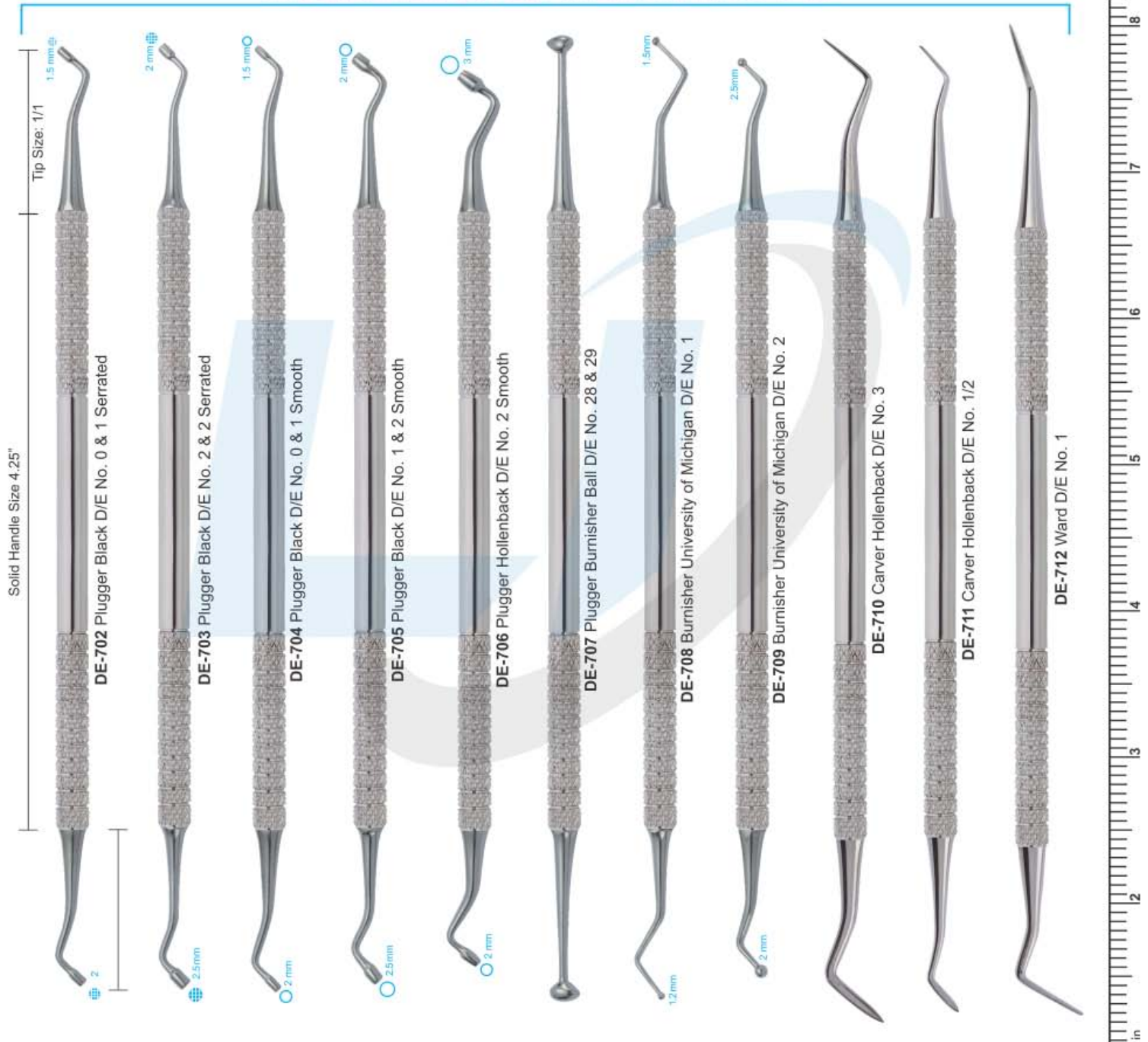

- Инструменты для реставрации
- Instruments pour amalgame
- Amalgampistolen

- Инструменти для реставрації
- instrumentos para amalgama
- تقطیع المنجم

AMALGAM INSTRUMENTS SOLID HANDLE 6MM, LENGTH 170MM

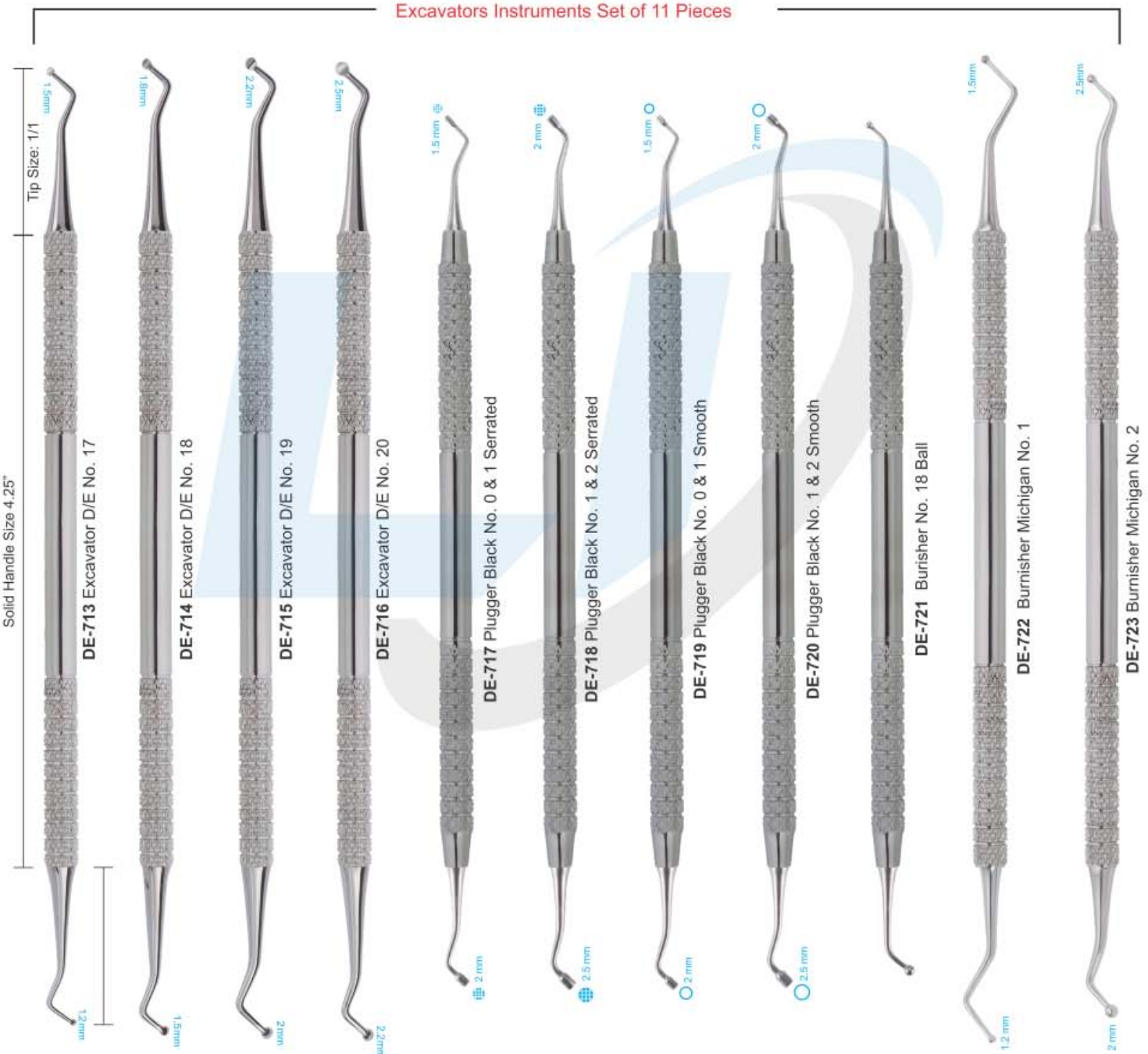
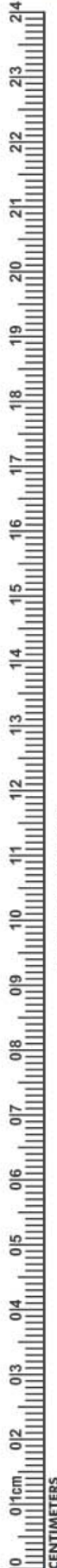

PERIODONTAL INSTRUMENTS



- Инструменты пародонтологические
- Instruments pour la parodontologie
- Instrumente für die Parodontologie
- Инструменти пародонтологічні
- instrumentos para periodoncia
- الصكوك اللثة

SICKLE SCALERS INSTRUMENTS SOLID HANDLE 6MM, LENGTH 170MM

SICKLE SCALERS





PERIODONTAL INSTRUMENTS

- Инструменты пародонтологические
- Instruments pour la parodontologie
- Instrumente für die Parodontologie

- Інструменти пародонтологічні
- instrumentos para periodoncía
- الصكوك اللثة

PERIODONTAL INSTRUMENTS SOLID HANDLE 6MM, LENGTH 170MM

JACQUETTE SCALERS

CRANE-KAPLAN



DE-731
30/33
Hygienist
Jacquette
#2, #4, #6,
#7, #8, #9

DE-732
31/32
Jacquette
#2, #4, #6,
#7, #8, #9

DE-733
34/35
Jacquette
#2, #4, #6,
#7, #8, #9

DE-734
H3/H4
Jacquette
#2, #4, #6,

DE-735
14/15
Posterior
Jacquette
#2, #4, #6,

DE-736
CK-6
#2, #4, #6,

PERIODONTAL INSTRUMENTS



- Инструменты пародонтологические
- Instruments pour la parodontologie
- Instrumente für die Parodontologie
- Инструменти пародонтологічні
- instrumentos para periodoncia
- الصكوك اللثة

PERIODONTAL INSTRUMENTS SOLID HANDLE 6MM, LENGTH 170MM SCALER/CURETTE SETS



DE-737
11/12
Scaler
#2, #6,
#7, #8

DE-738
11A/12A
Scaler
#2, #4, #6,

DE-739
11/12S
Modief
McCall
#4, #6

DE-740
13S/14S
Pointed
Curette
#2, #4, #6
#7, #8, #9

DE-741
MTC 13/14
Pointed
Curette
#4, #6

DE-742
17S/18S
Curette
#2, #4, #6
#7, #8, #9

DE-743
19/20
Curette
#2



CURETTES

- Кюрети
 - Curetas
 - Küretten
- Кюрети
 - Curette
 - کرتس

SCALER/CURETTE SETS

GOLDMAN-FOX SET



- | | | | | | | | | | |
|------------------------------------|---|--|---|---|--|--|--|---|---|
| DE-744
103/106
#4, #6 | DE-744A
104/105
Hoe/Chisel
#4, #6 | DE-745
107/108
#2, #4, #6
#7, #8 | DE-746
107/108S
Modief
#2, #4 | DE-747
1/2
(shown)
#2, #4, #6
#7, #8, #9 | DE-749
3/4†
(shown)
#2, #4, #6
#7, #8, #9 | DE-751
5/6†
(shown)
#2, #4, #6
#7, #8, #9 | DE-754
7/8†
(shown)
#2, #4, #6
#7, #8, #9 | | |
| | | | | DE-748
1/2
Rigid
#2, #4, #6
#7, #8, #9 | DE-750
3/4
Rigid
#2, #4, #6
#7, #8, #9 | DE-752
5/6
Rigid
#2, #4, #6
#7, #8, #9 | DE-753
5/6
Extra Rigid
#4, #6 #7, #8 | DE-755
7/8
Rigid
#2, #4, #6
#7, #8, #9 | DE-756
7/8
Extra Rigid
#2, #4, #6
#7, #8, #9 |

**SCALER/CURETTE SETS INSTRUMENTS
SOLID HANDLE 6MM, LENGTH 170MM**

CURETTES



- Кюрети
- Curetas
- Küretten
- Кюрети
- Curette
- كرتس

GRACEY CURETTE INSTRUMENTS SOLID HANDLE 6MM, LENGTH 170MM GRACEY CURETTES

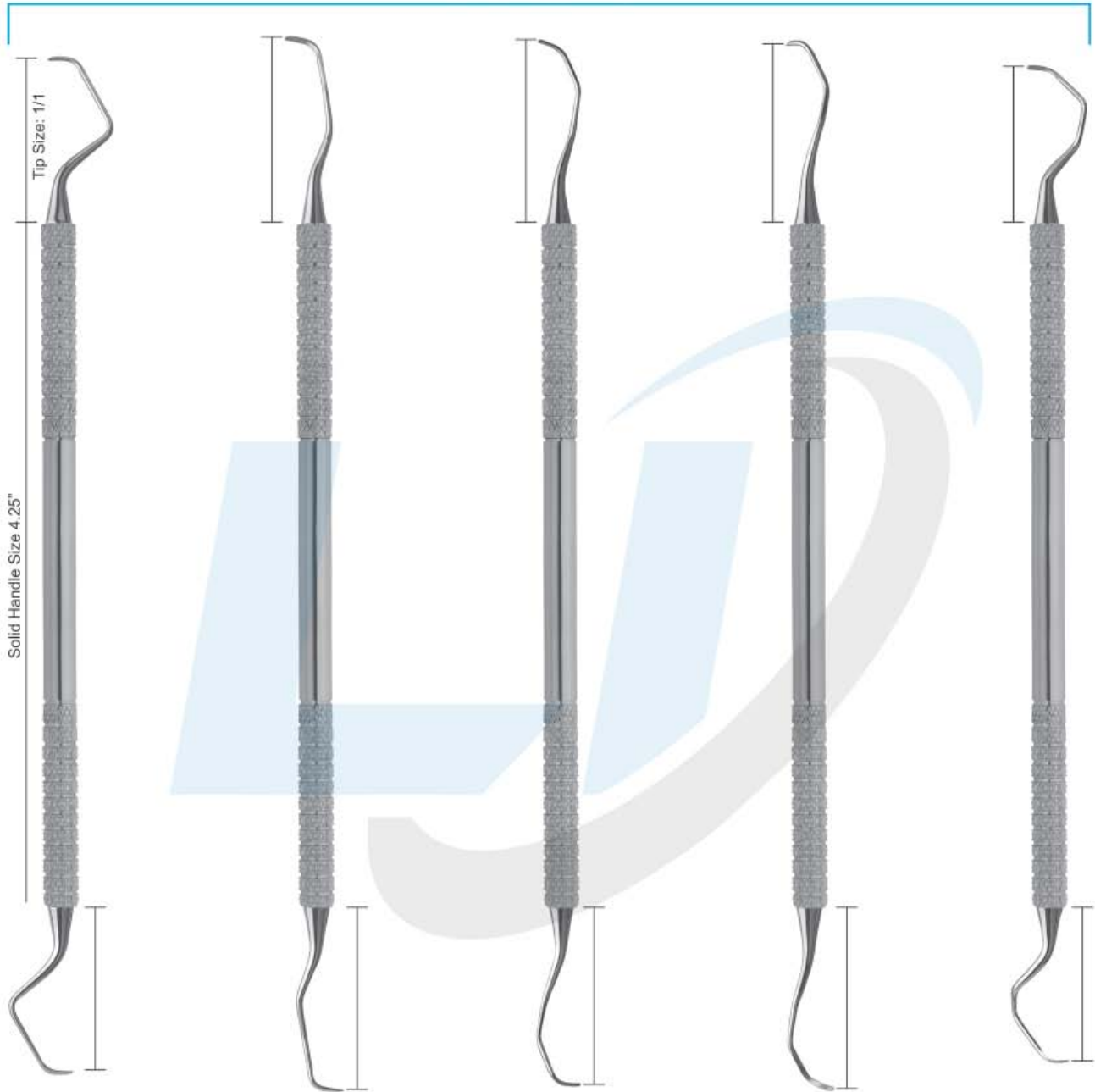

DE-757
9/10†
(shown)
#2, #4, #6
#7, #8, #9

DE-759
11/12†
(shown)
#2, #4, #6
#7, #8, #9

DE-792
13/14†
(shown)
#2, #4, #6
#7, #8, #9

DE-765
15/16†
(shown)
#2, #4, #6
#7, #8, #9

DE-767
17/18
#2, #4, #6
#7, #8, #9

DE-758
9/10
Rigid
#2, #4, #6
#7, #8

DE-760 **DE-761**
11/12 11/12
Rigid Extra Rigid
#2, #4, #6 #4, #6 #7,
#7, #8, #9 #8

DE-793 **DE-764**
13/14 13/14
Rigid Extra Rigid
#2, #4, #6 #4, #6 #7,
#7, #8, #9 #8

DE-766
15/16
Rigid
#2, #4, #6
#7, #8, #9

DE-768
17/18
Rigid
#2, #4, #6
#7, #8, #9

- Кюрети
- Curetas
- Küretten
- Кюрети
- Curette
- کرتس



**CURETTE INSTRUMENTS
HOLLOW HANDLE 8.5MM, LENGTH 170MM**

**CURETTE INSTRUMENTS
SOLID HANDLE 6MM, LENGTH 170MM**

**CURETTE INSTRUMENTS
SOLID HANDLE 6MM, LENGTH 170MM**

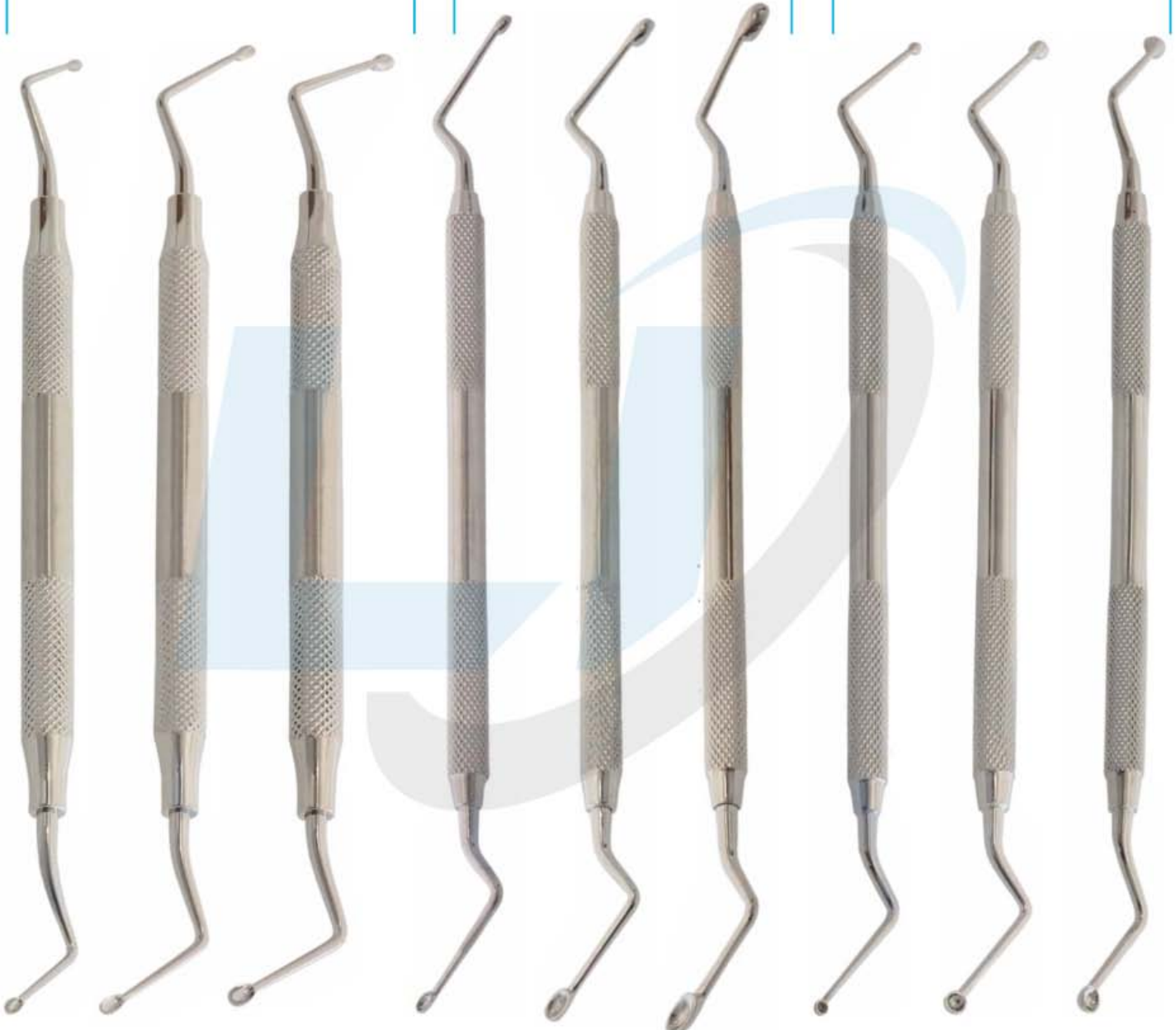

DE-769
Hemingway
2mm, 2mm

DE-770
Hemingway
3mm, 3mm

DE-771
Hemingway
4mm, 4mm

DE-772
Hemingway
2mm, 2mm

DE-773
Hemingway
3mm, 3mm

DE-774
Hemingway
4mm, 4mm

DE-775
Hemingway
2mm, 2mm

DE-776
Hemingway
3mm, 3mm

DE-777
Hemingway
4mm, 4mm

EXCAVATORS



- Экскаваторы
- Excavateurs
- Excavatoren
- Excavatori
- Excavadores
- حفارات

EXCAVATORS INSTRUMENTS SOLID HANDLE 6MM, LENGTH 170MM SPOONS



DE-778
E1
(12-9-15)
#41, #6

DE-779
E2
(15-9-15)
#41, #6

DE-780
E3
(25-9-15)

DE-781
6

DE-782
14

DE-783
17
#41, #6,
#7, #8

DE-784
18
#41, #6,
#7, #8

DE-785
19
#41, #6,
#7, #8

DE-786
38/39
(11.5-7-14)
#41, #6, #7

- Экскаваторы
- Excavatori
- Excavateurs
- Excavadores
- Excavatoren
- حفارات

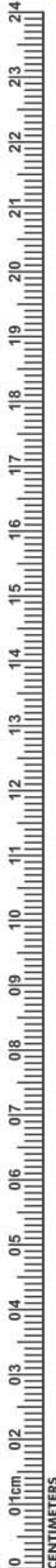

OVAL SPOONS/DARBY-PERRY

EXCAVATORS INSTRUMENTS SOLID HANDLE 6MM, LENGTH 170MM

EXCAVATORS

Model	Tip Size	Category
DE-787 17W	1.2	Oval Spoons/Darby-Perry
DE-788 18W	1.5	Oval Spoons/Darby-Perry
DE-789 19W	1.8	Oval Spoons/Darby-Perry
DE-790 220/221 Darby-Perry #41, #6	1.5	Oval Spoons/Darby-Perry
DE-791 2 Glick	1.5	Excavators
DE-792 31L #41, #6	1.0	Excavators
DE-793 31W Oval Spoon	1.3	Excavators
DE-794 32L #41, #6	1.5	Excavators
DE-795 33L #41, #6	2.0	Excavators

EXCAVATORS



- Экскаваторы
- Excavateurs
- Excavatoren
- Excavatori
- Excavadores
- حفارات

EXCAVATORS INSTRUMENTS SOLID HANDLE 6MM, LENGTH 170MM

BLADES





EXCAVATORS

- Экскаваторы
- Excavateurs
- Excavatoren

- Экскаватори
- Excavadores
- حفارات

EXCAVATORS INSTRUMENTS SOLID HANDLE 6MM, LENGTH 170MM

ENGLISH PATTERNS



DE-802
Goldstein
Interproximal
Excavator

DE-803
243

DE-804
244

DE-805
245

DE-806
246

DE-807
125/126
#41, #6

DE-808
127/128
#41, #6

DE-809
129/130
#41, #6

DE-810
131/132
#41, #6

DE-811
153/154

FILLING INSTRUMENTS



- Инструменты для реставрации
- Instruments pour plombage
- Füllungsinstrumente (mit Kontrawinkel)
- Инструменти для реставрації
- Instrumentos para obturaciones
- ملء الصكوك

HATCHETS

RESTORATIVE INSTRUMENTS SOLID HANDLE 6MM, LENGTH 170MM

Tip Size: 1/1

Solid Handle Size 4.25"

DE-813
13/14
(20-9-14)

DE-814
15/16
(15-8-14)

DE-815
17/18
(10-6-14)
#41, #6

DE-816
51/52
(15-8-12)

DE-817
53/54
(10-6-12)
#41, #6

ANTERIOR

DE-812
8/9H
(10-7-14)
#41, #6

DE-818
8A
#41, #6

DE-819
11
#41, #6

DE-820
179

DE-821
G

DE-822
1/2
Trico

DE-823
DPT6
Darby Perry
Trimmer

DE-824
W1

DE-825
1
Woodson
#41, #6

INCHES
10 11 12 13 14 15 16 17 18 19



FILLING INSTRUMENTS

- Инструменты для реставрации
- Instruments pour plombage
- Füllungsinstrumente (mit Kontrawinkel)

- Инструменти для реставрації
- Instrumentos para obturaciones
- ملء الصكوك

CARVERS

RESTORATIVE INSTRUMENTS SOLID HANDLE 6MM, LENGTH 170MM



DE-826
Inter-proximal
#41, #6, #7



DE-827
Inter-proximal
Off-Angle



DE-828
1/2-3
Hollenback
#41, #6,
#7, #8



DE-829
3S
Hollenback
#41, #6, #7

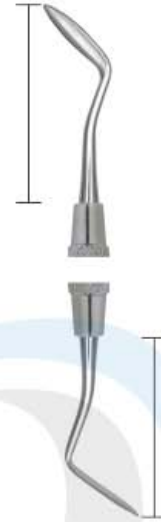

DE-830
3
Hollenback



DE-831
8
Wiland
Minn.IPC1
#41, #6, #7

TANNER

WALL

WARD



DE-832
3
Tanner



DE-833
4
Tanner



DE-834
5
Tanner



DE-835
6
Tanner



DE-836
1
Wall



DE-837
3
Wall



DE-838
1
Ward



DE-839
2
Ward

AMALGAM CARVERS



- Инструменты для реставрации
- Instruments pour amalgame
- Amalgampistolen
- Инструменти для реставрації
- instrumentos para amalgama
- تطبيع المنغم

RESTORATIVE INSTRUMENTS

SOLID HANDLE 6MM, LENGTH 170MM

Tip Size: 1/1
Solid Handle Size 4.25"

ANDREW

- DE-841 2 Andrew
- DE-842 3 Andrew

CLAPPISON/FRAHAM

- DE-843 4 Clappison
- DE-844 2/3 Frahm #41, #6
- DE-845 104

HOLLENBACK

- DE-846 1 Hollenback 2 Modified Cleoid Small
- DE-847 1 Hollenback 2 Modified Cleoid Large
- DE-848 1 Hollenback
- DE-849 2 Hollenback

THARP

- DE-850 L7 Levy
- DE-851 SHO-A Shoshan
- DE-852 18 Sprengel
- DE-853 1 Tharp
- DE-854 2 Tharp

INCHES 10 11 12 13 14 15 16 17 18 19

- Инструменты для реставрации
- Instruments pour amalgame
- Amalgampistolen

- Инструменти для реставрації
- instrumentos para amalgama
- تقطیع المنجم

RESTORATIVE INSTRUMENTS SOLID HANDLE 6MM, LENGTH 170MM

CARVERS

AMALGAM FILES

HOES Forming Line Angles on Anterior Preparations.

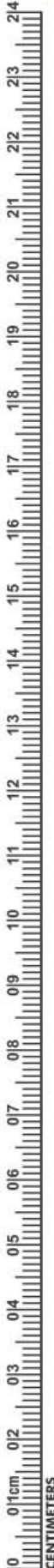

DISCOID-CLEOIDS

DISCOID-CLEOIDS



FILLING INSTRUMENTS



- Инструменты для реставрации
- Instruments pour plombage
- Füllungsinstrumente (mit Kontrawinkel)
- Инструменти для реставрації
- Instrumentos para obturaciones
- ملء الصكوك

RESTORATIVE INSTRUMENTS
SOLID HANDLE 6MM, LENGTH 170MM

MARGIN TRIMMERS

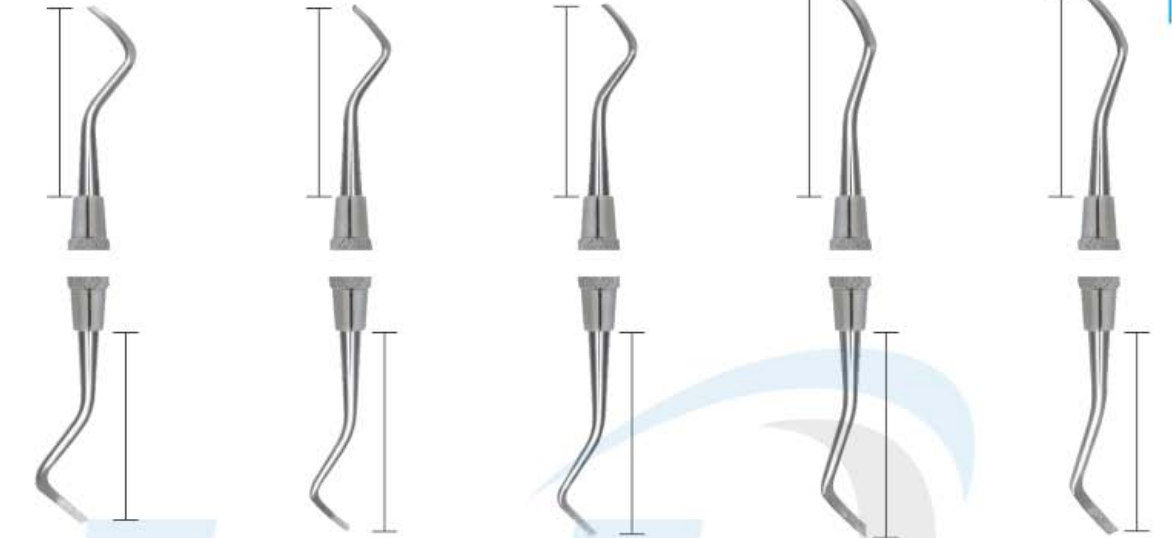

DE-871
27
(13-80-8-14)
Mesial

DE-872
28
(10-95-7-14)
Distal
#41, #6

DE-873
29
(10-80-7-14)
Mesial
#41, #6

DE-874
77/78
(15-95-8-12)
Distal

DE-875
79/80
(15-80-8-12)
Mesial

ANGLE FORMERS

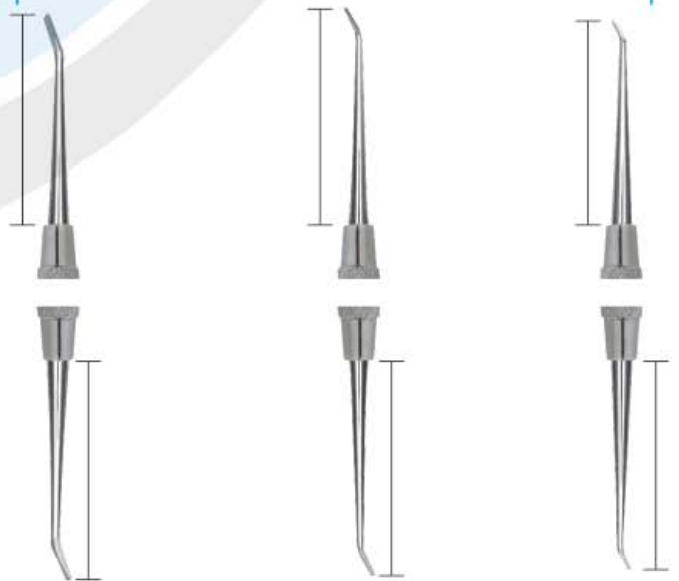

DE-876
30/31
(12-80-5-8)

DE-877
32/33
(9-80-4-8)

DE-878
34/35
(7-80-2.5-9)

DE-870
26
(13-95-8-14)
Distal



- Инструменты для реставрации
- Instruments a modeler
- Modellierinstrumente

- Инструменти для реставрації
- Instrumentos para modelar
- أدوات تقطيع

P.K. THOMS WAXING INSTRUMENTS SOLID HANDLE 6MM, LENGTH 170MM

P.K. THOMAS WAXING INSTRUMENTS

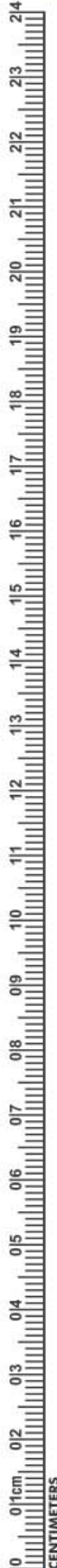

DE1-884
P.k. Thomas Waxing
Instruments
Kit



COMPOSITE FILLING INSTRUMENTS



- Инструменты для реставрации
- Instruments pour plombage
- Füllungsinstrumente (mit Kontrawinkel)

- Інструменти для реставрації
- Instrumentos para obturaciones
- ملء الصكوك

Composite Gold Tip Instruments

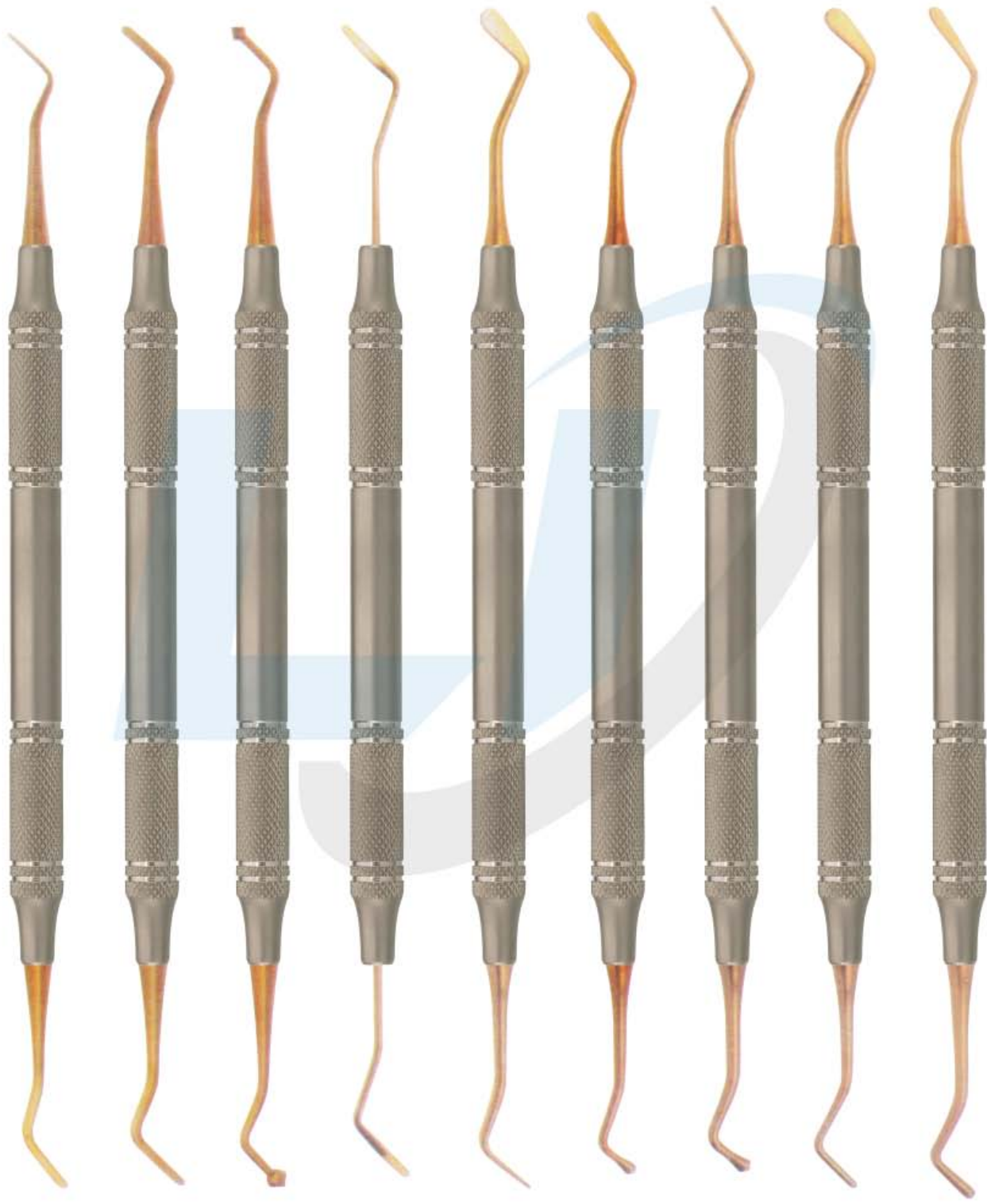

DE1-892

DE2-892

DE3-892

DE4-892

DE5-892

DE6-892

DE7-892

DE8-892

DE9-892





COMPOSITE FILLING INSTRUMENTS

- Инструменты для реставрации
- Instruments pour plombage
- Füllungsinstrumente (mit Kontrawinkel)

- Инструменти для реставрації
- Instrumentos para obturaciones
- ملء الصكوك

Composite Gold Tip Instruments



DE10-892
Markley 2



DE11-892
Westcott N.21



DE12-892
NYU/B2



DE13-892
Filling instruments



DE14-892
Ball Filling Instruments



DE15-892
Filling Instruments

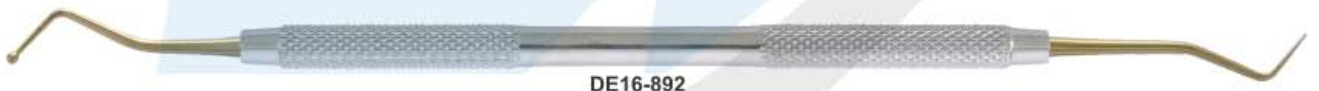

DE16-892
Filling Instruments



DE17-892
Filling Instruments



DE18-892
Plastic Filling Instruments



DE19-892
Heidemann



DE20-892
Plastic Filling Instruments



FILLING INSTRUMENTS



- Инструменты для реставрации
- Instruments pour plombage
- Füllungsinstrumente (mit Kontrawinkel)
- Инструменти для реставрації
- Instrumentos para obturaciones
- ملء الصكوك

COMPOSITE INSTRUMENTS TITANIUM BLUE ENDODONTIC

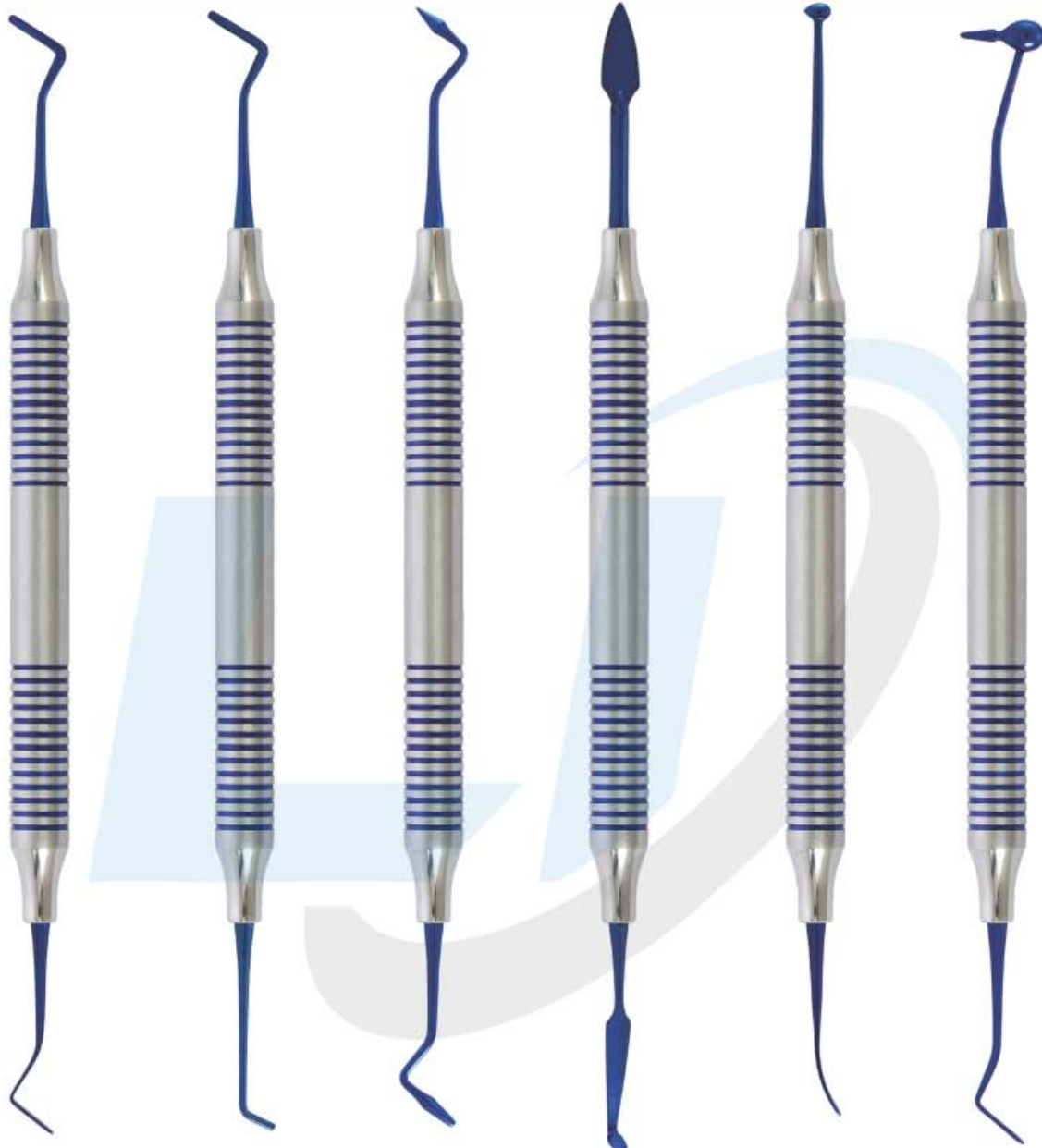

DE21-892

DE22-892

DE23-892

DE24-892

DE25-892

DE26-892



DE27-892
Composite Instruments Blue
Titanium with Cassettes





MISCELLANEOUS PRODUCTS

- Прочие товары
- Divers produits et services
- Sonstige Produkte

- Інші товари
- Varios Productos
- المنتجات المتنوعة



DE28-892
X Ray Film Hangers

DE29-892
X Ray Film Hangers

DE30-892
X Ray Film Hangers

DE31-892
X Ray Film Hangers

DE32-892
X Ray Film Hangers

DE33-892
X Ray Film Hangers

DE34-892
X Ray Film Hangers

DE35-892

DE36-892

DE37-892

DE40-892
Napkin Holder with Plastic Chain

DE41-892
Napkin holder with metal chain

DE38-892 Set of 9 Pcs.
DE39-892 Set of 11 Pcs.

Key Rings

Mouth Props
DE42-892 Small
DE43-892 Medium
DE44-892 Large

DE45-892

DE46-892

DE47-892

DE48-892

DE49-892

DE50-892

FILLING INSTRUMENTS



- Инструменты для реставрации
- Instruments pour plombage
- Füllungsinstrumente (mit Kontrawinkel)
- Инструменти для реставрації
- Instrumentos para obturaciones
- ملء الصكوك

CHISELS

HOES





CEMENT SPATULAS

- Шпатели для цемента
- Spatules à ciment
- Zementspatel

- Шпатели для цементу
- Espátulas para cemento
- ملاعق الاسمنت

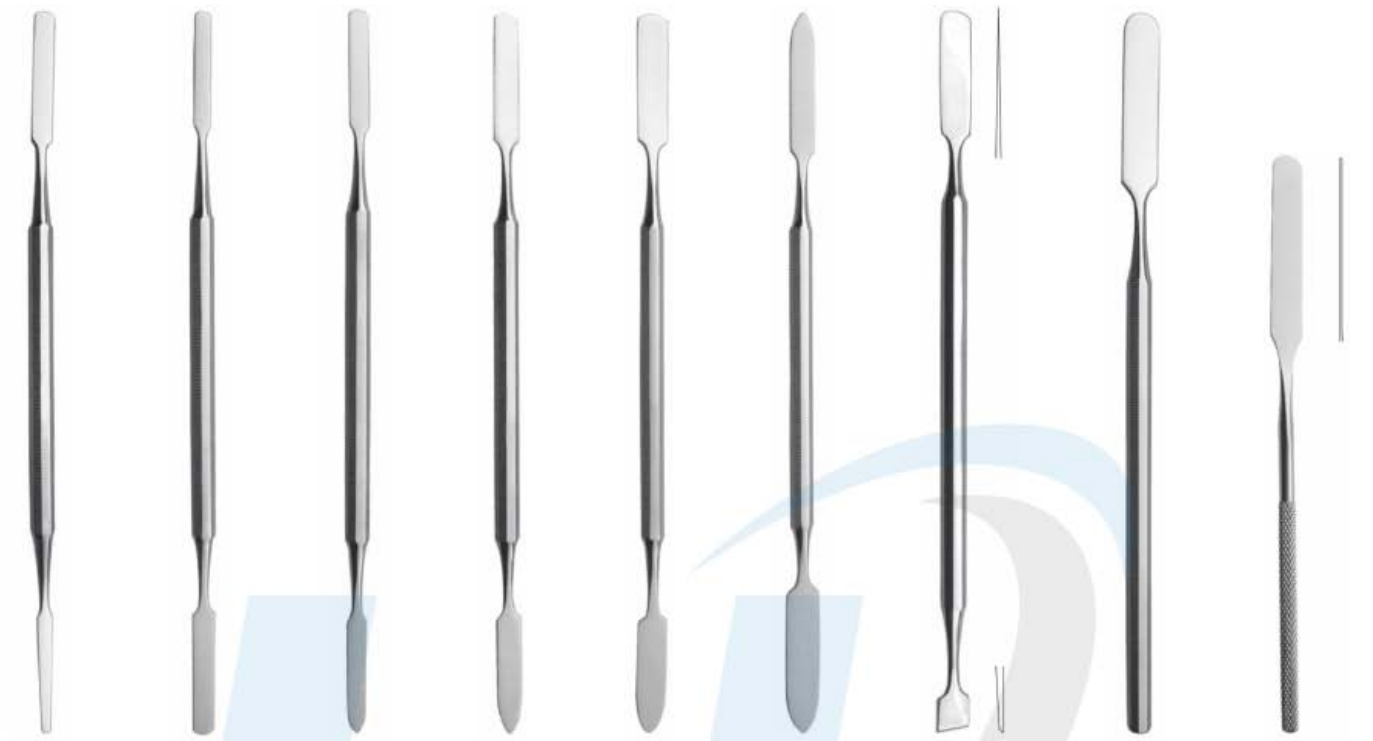

DE-893 00 DE-894 0 DE-895 1 DE-896 2 DE-897 3 DE-898 4 DE-899 3 Weston DE-900 1 medium cement DE-901 1



DE-902 Le Cron DE-903 Le Cron DE-904 Le Cron DE-905 MSY DE-906 MSY DE-907 Le Cron DE-908 Hylin DE-909 Hylin DE-910 Hylin DE-911 Zahle DE-912 Zahle DE-913 Zahle DE-914 Gritman

E-mail: info@luminesintl.com web: www.luminesintl.com

WAX KNIVES



- Ножи для воска
- Couteaux a cire
- Wachsmesser
- Ножі для воску
- Cuchillos para cera
- السكاكين الشمع

ALGINATE, PLASTER SPATULAS, WAX KNIVES PLASTER FOR KNIVES & PLASTER SHEAR



DE-915
Wooden Handle
Fig. 5
21.5 cm



DE-916
Wooden Handle
Fig. 7
19.5 cm curved



DE-917
Wooden Handle
Fig. 8
20 cm curved



DE-918
Wooden Handle
Fig. 9
22.5 cm curved



DE-919
Hook Knives



DE-920
Fig. 1
Lessmann
12.5 cm



DE-921
Fig. 2
Lessmann
17 cm



DE-922
Fig. 1
with small spoon
12.5 cm



DE-923
Fig. 2
with large spoon
17 cm



DE-924
Bacolite Handle
Wax Knives,
Small



DE-925
Bacolite Handle
Wax Knives,
Large



DE-926
Wooden Handle
Wax Knives,
Small



DE-927
Wooden Handle
Wax Knives,
Large



DE-928
Plaster Knife



DE-929
Fig. 1
17 cm



DE-930
Fig. 3
16 cm



DE-931
Fig. 4
16 cm



DE-932
Special Inox
19.5 cm



- Артикуляторы
- Artocilar
- Artikulations

- Артикулятори
- Articulier
- ارتیکولاتورس



DE-933

Technical Datas:

Intercondylar distance	120 mm.
condylar inclination	fixed at 30°
Bennet angle	fixed at 7°
Incisal table inclination	10°
Distance between mounting plates	85 mm.
Weight	400 gr.
Opening (item 5000)	125°
Opening (item 5010)	180°



DE-934

Technical Datas:

Intercondylar distance	110 mm.
condylar inclination	fixed at 30°
Bennet angle	fixed at 7°
Incisal table inclination	flat
Distance between mounting plates	85 mm.
Weight	450 gr.
Opening	180°



DE-935

Stainless Steel Finishing
DE-936
Royal Blue



DE-937



DE-938



DE-939



DE-940



DE-941



DE-942



DE-943



DE-944



DE-945



DE-946
Nakawalni
Dental Laboratory
Instrument

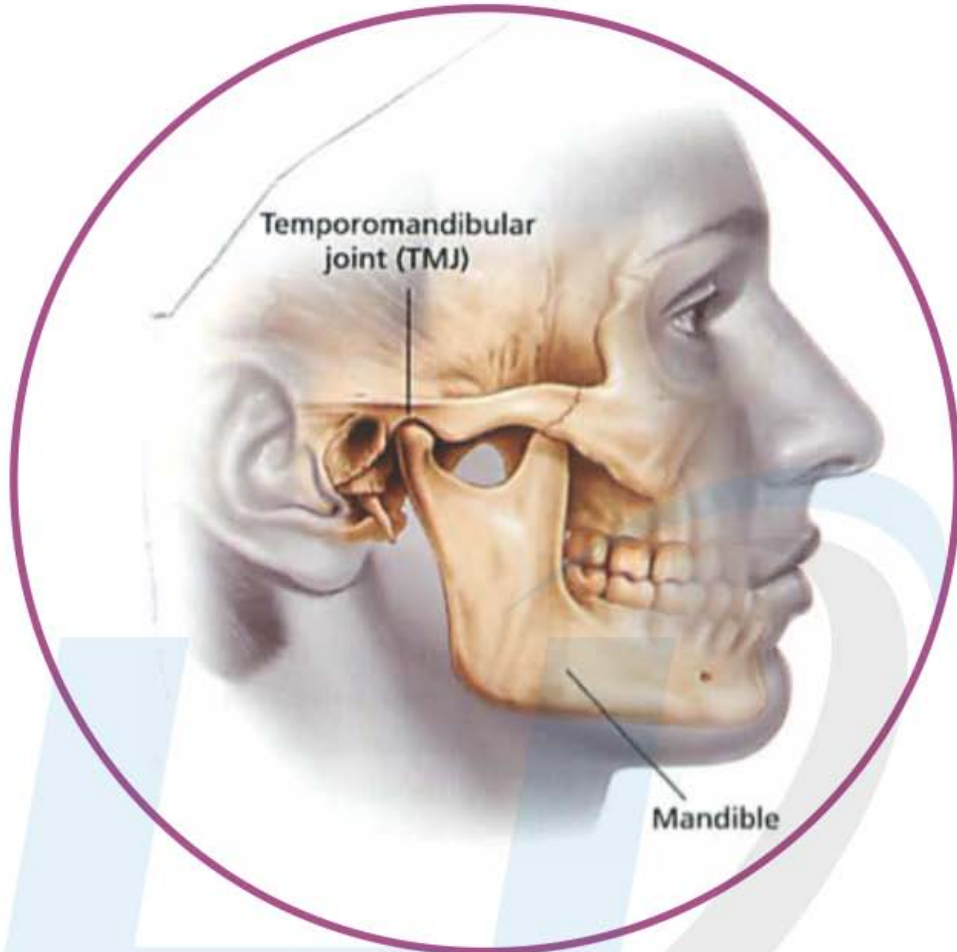

- Роторасширители
- Ecarteurs - Ouvre-bouches
- Vestibulumabhalter / Mundspanner
- Роторозширювачі
- Separadores - Abre-bocas
- الكاشطات - الكمامات القم

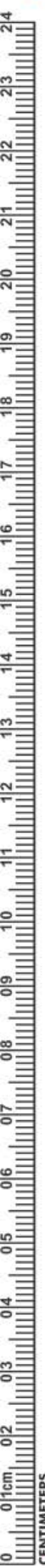

DE-947
Mouth Gag Molt
11 cm for (Children)



DE-948
Mouth Gag Molt
14 cm for (Adults)



Cheek Retractor
DE-949 140 mm
DE-950 180 mm



Cheek Retractor
DE-951 140 mm



DE-952
Wangen Holder,
vestibule
15 cm, with or without
lip protection,



DE-953
Wangen Holder,
vestibule 15 cm, with
or without lip protection,



DE-954
Wangen Holder
Wangen holder with dual
function, 17 cm,



DE-955
140 mm

DE-956
150 mm

Cheek Retractor

RETRACTORS - MOUTH GAGS



- Роторасширители
- Ecarteurs - Ouvre-bouches
- Vestibulumabhalter / Mundspanner
- Роторозширювачі
- Separadores - Abre-bocas
- الكاشطات - الكمامات الفم



DE-957
Fig. 1
weitlander
10.5cm
13.5cm



DE-958
Fig. 2
weitlander
10.5cm
13.5cm



DE-959
Stainless Steel
Double
Ended Cheek
Retractors



DE-960
Stainless Steel
Single
Ended Cheek
Retractors



Weitlander
DE-961 11cm
DE-962 13cm
DE-963 15cm



DE-967
Denhard
12 cm



DE-968
Roser-König
16 cm



DE-969
Roser-König
19 cm



Jennings
DE-964 11cm
DE-965 13cm
DE-966 15cm





RETRACTORS

Wound, Bendable
Retractor, individually or as saving kit!

- Ранорасширители
- Ecarteurs
- Wundhaken

- Ранорозширювачі
- Separadores
- الكاشحات

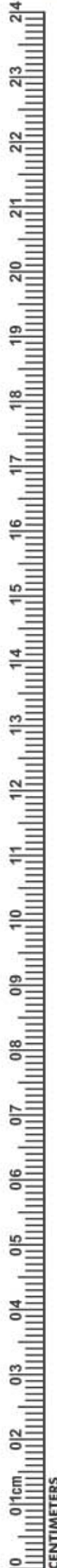

DE-970
Cheek Retractor
Long



DE-971
Cheek Retractor
Long



DE-972
Cheek Retractor
Long



Retractor with Ergo Grip DE-973 24 cm, ergonomic handle,



DE-974
Cheek Retractors,
Retractor Ivory
Width adjustable & fixable, 20 cm,



Cheek Retractors, tongue depressors DE-975 19 cm



Cheek Retractors, Minnesota DE-976 16 cm



Cheek Retractors, DE-977 20 cm easy to bend by hand,



Cheek Retractors, retractor and tongue pushers BISHOP DE-978 16 cm,



Retractors Cheek retractor combination DE-979 25 cm,

RETRACTORS



- Ранорасширители
- Ecarteurs
- Wundhaken
- Ранорозширювачі
- Separadores
- الكاشحات



DE-982
Retractors, Unique
Length 175 mm,
angled 45°



DE-983
Retractors, Unique
Length 175 mm,
angled 90°



DE-984
Retractors
16cm



DE-985
Retractors
19cm



DE-986
Retractors, Mini-Langenbeck
16 cm, hooks 22 mm,



DE-987
Retractors, Cheek
retractors combination
21 cm, 2



DE-988
Mini Retractor
about 8 cm,



DE-989
Retractors
17 cm, hooks 22 mm



- Ранорасширители
 - Ecarteurs
 - Wundhaken
- Ранорозширювачі
 - Separadores
 - الكاشحات



DE-990
Retractors, surgical-flat
surgically-flat, 21 cm, hook
30x16 mm,



DE-991
Retractors, surgical-flat
surgically-flat, 21 cm, hook
42x11 mm



DE-992
Retractors, surgical-flat
surgically-flat, 21 cm, hook
63x12 mm,



Retractors, surgical-flat
surgically-flat, 21 cm, hook
DE-993 30x16 mm,
DE-994 42x11 mm,
DE-995 63x12 mm,



Retractors, Langenbeck
21 cm, hook
DE-996 30x11 mm
DE-997 30x16 mm,



DE-998
Retractors
21 cm,



DE-999
Farabeuf
(120 X 12mm
Set of 2 pices)



DE-1000
Retractor Seldin



DE-1001
FELDMAN
RETRACTOR
5-1/2", 14cm



GUM SCISSORS



- Ножницы десневые
- Ciseaux a gencives
- Zahnfleischscheren
- Ножиці для ясен
- Tijeras para encias
- مقص صمغ



DE-1002
Iris
115mm
Straight



DE-1003
Iris
115mm
Curved



DE-1004
Goldman-Fox
130mm
Saw edge, straight



DE-1005
Goldman-Fox
130mm
Saw edge, Curved



DE-1006
La Grange
115mm
Saw edge, double Curved



Mayo
DE-1007 140mm
DE-1008 170mm
DE-1009 230mm
Straight



Mayo
DE-1010 140mm
DE-1011 170mm
DE-1012 230mm
Curved



Metzenbaum
DE-1013 145mm
DE-1014 180mm
DE-1015 200mm
Straight



Metzenbaum
DE-1016 145mm
DE-1017 180mm
DE-1018 200mm
Curved



DE-1019
Kelly
160mm
Straight



DE-1020
Kelly
160mm
Curved



DE-1021
Iris
115mm
Straight



DE-1022
Iris
115mm
Curved



DE-1023
La Grange
115mm
Double Curved



DE-1024
Goldman-Fox
130mm, Straight



DE-1025
Goldman-Fox
130mm, Curved



DE-1026
Kelly
160mm, Curved



DE-1027
Iris
115mm, Straight



DE-1028
Iris
115mm, Curved



DE-1029
Micro Iris
90mm, Curved



- Ножницы десневые
- Ciseaux a gengivas
- Zahnfleischscheren

- Ножиці для ясен
- Tijeras para encias
- مقص صغ



DE-1030
Iris
115mm
Angled



DE-1031
Iris
115mm
Curved



DE-1032
Goldman-Fox
130mm
Saw edge,
straight



DE-1033
Goldman-Fox
130mm
Saw edge,
curved



DE-1034
Goldman-Fox
130mm
Saw edge,
double curved



DE-1035
La Grange
115mm
Saw edge,
double curved



DE-1036
Neumann
120mm
Saw edge,
double curved



DE-1037
Kilner (Ragnell)
120mm
Straight



DE-1038
Kilner (Ragnell)
120mm
Curved



DE-1039
Joseph
140mm
Straight



DE-1040
Joseph
140mm
Curved



DE-1041
Kelly
160mm
Straight



DE-1042
Kelly
160mm
Curved



DE-1043
Locklin
160mm
Saw edge,
angular



DE-1044
Locklin
120mm
160mm
Saw edge,
angular



DE-1045
Dean
170mm
Saw edge,
angular



DE-1046
Spencer
90mm



DE-1047
Spencer
130mm



DE-1048
Spencer
115mm



DE-1049
Noyes
110mm, Straight



DE-1050
Noyes
110mm
Curved



DE-1051
Noyes
110mm
Angular



DE-1052
Castroviejo
150mm
Curved

NEEDLE HOLDERS



- Иглодержатели
 - Porte-aiguilles
 - Nadelhalter
- Голкотримачи
 - Porta-agujas
 - اصحاب ابرة



DE-1053
130mm
Straight



DE-1054 Mayo
130mm 130mm
DE-1055 Mayo
160mm 160mm
DE-1056 Mayo
180mm 180mm
Straight Curved



DE-1057 Mayo
140mm 140mm
DE-1058 Mayo
200mm 200mm
Straight Curved



DE-1059 Metzenbaum
145mm 145mm
DE-1060 Metzenbaum
200mm 200mm
Straight Curved



DE-1061
Beebee
110mm
Saw edge,
straight



DE-1062
Beebee
110mm
Saw edge,
curved



DE-1063
Beebee
110mm
Saw edge, straight



DE-1064
Beebee
110mm
Saw edge, curved

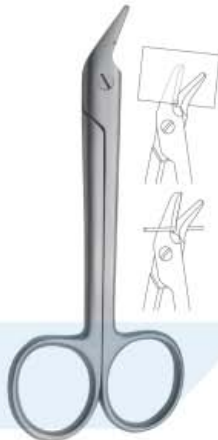

DE-1065
Universal
120mm
Saw edge



DE-1066
Universal
120mm

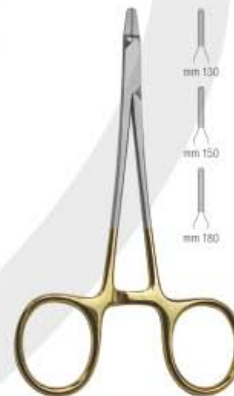

Crile
DE-1067 130mm
DE-1068 150mm
DE-1069 180mm



DE-1070
Halsey
130mm



DE-1071
Baumgartner
130mm



DE-1072
Derf
120mm



DE-1073
Delicate
150mm



Mayo-Hegar
DE-1074 130mm
DE-1075 160mm
DE-1076 180mm
DE-1077 200mm



DE-1078
Crile-Wood
150mm
straight



DE-1079
Crile-Wood
150mm
curved



- Иглодержатели
- Porte-aiguilles
- Nadelhalter

- Голкотримачі
- Porta-agujas
- اصحاب ابرة



Castroviejo
DE-1080 130mm
DE-1081 150mm
DE-1082 180mm



DE-1083
 Halsey
 130mm



DE-1084
 Baumgartner
 130mm



DE-1085
 Derf
 120mm



DE-1086
 Delicate
 150mm



DE-1087
 Adson
 170mm



Mayo-Hegar
DE-1088 130mm
DE-1089 160mm
DE-1090 180mm
DE-1091 200mm



DE-1092
 Crile-Wood
 150mm

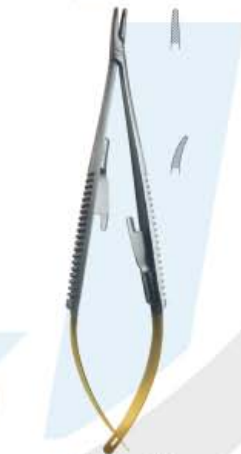

Castroviejo
DE-1093 str 140mm cvd
DE-1094 str 180mm cvd



Olsen-Hegar Needle
 Holder With Scissors
DE-1095 140mm



Gillies Needle
 Holder With Scissors
DE-1096 160mm



Mathieu
DE-1097 140mm
DE-1098 170mm



Castroviejo
DE-1099 str 140mm cvd
DE-1100 str 180mm cvd



Olsen-Hegar Needle
 Holder With Scissors
DE-1101 140mm



Gillies Needle
 Holder With Scissors
DE-1102 160mm

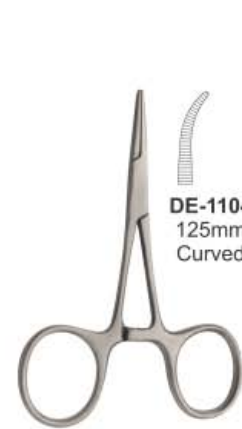

DE-1104
 125mm
 Curved
 Hartmann (Baby
 Mosquito)
DE-1103 90mm straight



DE-1106
 Curved
 Halstead Mosquito
DE-1105 125mm
 Straight

HAEMOSTATIC FORCEPS & TOWEL CLAMPS



- Зажимы артериальные, зажимы для салфеток
- Pincas hemostatiques, Pincas a compresas
- Arterienklemmen, Tuschklemmen
- Затискачі артеріальні, затискачі для серветок
- Pinzas hemostaticas, Pincas para compresas
- الملقط هایموستاتیک المشابک منشفه

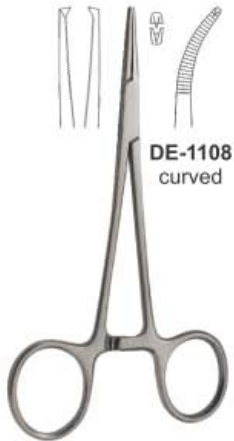

DE-1108
curved

Halstead Mosquito 1x2
DE-1107 125mm
straight



DE-1110
curved

Kelly
DE-1109 140mm
straight



DE-1115 140mm
DE-1116 160mm
DE-1117 180mm
DE-1118 200mm
curved

Rochester-Pean
DE-1111 140mm
DE-1112 160mm
DE-1113 180mm
DE-1114 200mm
straight



DE-1123 140mm
DE-1124 160mm
DE-1125 180mm
DE-1126 200mm
curved

Rochester-Kocher 1x2
DE-1119 140mm
DE-1120 160mm
DE-1121 180mm
DE-1122 200mm
straight



DE-1127
curved

DE-1127
Kelly-Rankin
160mm
straight



Lorna
DE-1129 100mm
DE-1130 130mm



DE-1131
Allis-Baby 3:4
150mm



DE-1132
Allis 4:5
200mm



DE-1133
Allis 6:7
200mm



Backhaus
DE-1134 140mm
Not-perforating and
not-damaging



DE-1135
Backhaus
130mm



DE-1136
Backhaus
85mm



DE-1137
Jones
90mm

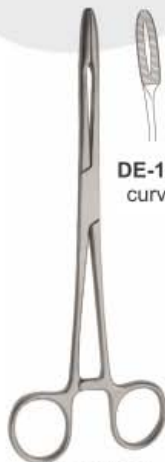

Gross Maier
Dressing Forceps
DE-1138 200mm straight

DE-1139
curved



Foerster
Dressing Forceps
DE-1140 200mm



Young
Tongue Forceps
DE-1141 170mm

Spare rubber



Collins
Tongue Forceps
DE-1142 170mm



- Инструменты для системы коффердам
- Pincas porte-crampons a digue
- Kofferdam Klammerzangen
- Инструменты для системи коффердам
- Pinzas de engrapar para dique de caucho
- السد المطاط الملقط المشابك



DE-1143
On request the Content of the rubber dam kit can be changed with other instruments.

- Content:**
- 01 Anisworth
 - 02 Brewer
 - 03 Clamps Stand
 - 04 Denture Plate
 - 05 Rubber Dam Frame
 - 06 Rubber Dam Box Lower Case
 - 07 Rubber Dam Box Upper Case
 - 08 Rubber Dam Clamp Fig. 212
 - 09 Rubber Dam Clamp Fig. 211
 - 10 Rubber Dam Clamp Fig. 8
 - 11 Rubber Dam Clamp Fig. 8A
 - 12 Rubber Dam Clamp Fig. 14
 - 13 Rubber Dam Clamp Fig. 14A
 - 14 Rubber Dam Clamp Fig. 0
 - 15 Rubber Dam Clamp Fig. 00
 - 16 Rubber Dam Clamp Fig. 2
 - 17 Rubber Dam Clamp Fig. 2A
 - 18 Rubber Dam Clamp Fig. 7

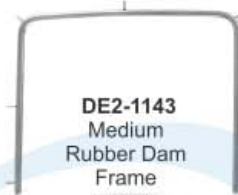
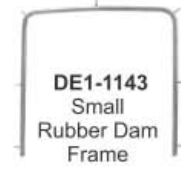

DE-1145
Brewer



DE1-1145
Stockes



DE-1147
Palmer



DE-1146
Ivory light weight



DE-1144
Anisworth



DE1-1144
Anisworth



DE2-1144
Anisworth



DE3-1144
Ivory



DE-1148
Seaparating
Elastic Plier

RUBBER DAM CLAMPS



- Кляммера для коффердама
- Crampons pour digue
- Kofferdam Klammern
- Кляммера для коффердама
- Grapas para dique de caucho
- المشابك السد المطاط



DE-1149
Fig. 15



DE-1150
Fig. 18



DE-1151
Fig. 24



DE-1152
Fig. 25



DE-1153
Fig. 26



DE-1154
Fig. 28



DE-1155
Fig. 30



DE-1156
Fig. 31



DE-1157
Fig. 51



DE-1158
Fig. 138



DE-1159
Fig. 139



DE-1160
Fig. 200



DE-1161
Fig. 201



DE-1162
Fig. 202



DE-1163
Fig. 203



DE-1164
Fig. 204



DE-1165
Fig. 205



DE-1166
Fig. 3



DE-1167
Fig. W3



DE-1168
Fig. 4



DE-1169
Fig. 56A



DE-1170
Fig. 7



DE-1171
Fig. 7A



DE-1172
Fig. 8



DE-1173
Fig. 8A



DE-1174
Fig. W8A



DE-1175
Fig. 10



DE-1176
Fig. 11



DE-1177
Fig. 12A



DE-1178
Fig. 13A



DE-1179
Fig. 14



DE-1180
Fig. 14A



DE-1181
Fig. 14AN



DE-1182
Fig. 22



DE-1183
Fig. 27



DE-1184
Fig. 207



DE-1185
Fig. 29



DE-1186
Fig. 206



DE-1187
Fig. 208



DE-1188
Fig. 209



DE-1189
Fig. 1



DE-1190
Fig. 1A



DE-1191
Fig. 2



DE-1192
Fig. 2A



DE-1193
Fig. W2A



DE-1194
Fig. 0



DE-1195
Fig. 00



DE-1196
Fig. 210



DE-1197
Fig. 211



DE-1198
Fig. 212



DE-1199
Fig. 6



DE-1200
Fig. 9



DE-1201
Fig. N06



DE-1202
Fig. U67



DE-1203
Fig. 214



DE-1204
Fig. P1



DE-1205
Fig. P2



DE-1206
Fig. G-1



DE-1207
Fig. G-2



- Инструменты для удаления коронок
 - Arrache-couronnes
 - Teleskopkronenzangen
- Инструменти для видалення коронок
 - Arranca-corona
 - مزيلات التاج



DE-1210
Crown Spreaders



DE-1211
Mershon
14 cm
Band Pusher



DE-1212
Fig. 0
Manual Crown Removers
Handle with 3 tips **DE1-1212**
Only 3 tips **DE2-1212 to DE4-1212**



DE2-1212



DE3-1212



DE4-1212



Manual Crown Removers
Handle with 3 tips **DE5-1212**
Only 3 tips **DE6-1212 to DE8-1212**



DE6-1212



DE7-1212



DE8-1212



DE-1213
Manual Crown Remover



DE-1214
Complete with 3 tips
and tightening keys

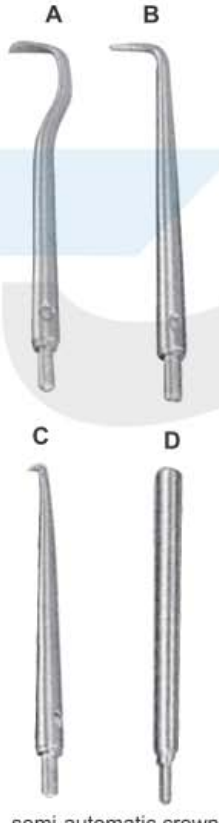

semi-automatic crown
& bridge remover



DE-1215



DE-1216
Manual Crown Remover



MATRIX RETAINERS



- Матрицедержатели
- Porte Matrices
- Matrizenspanner

- Матрицеутримувачи
- Porta Matrices
- مصفوفة الخدم



DE-1217
Fig. 5
Ivory 8
5 cm



DE-1218
Fig. 6
Ivory 8
6 cm



DE-1219
Fig. 7
Ivory 8
7 cm



DE-1220
Fig. 1
Tofflemire-Universal



DE87-1220



DE1-1220



DE2-1220

Siqveland Retainers



DE-1221
Fig. 3
Tofflemire-Junier



DE-1222
Fig. 3
Tofflemire-Senior



DE-1223
Narrow



DE-1224
Wide

Amalgam Well



DE-1225
Stainless Steel
Amalgam Well



DE-1226
Ivory 12



DE-1227
Ivory 1



DE-1228
Ivory



DE-1229
Elliot



Инструменты для амальгамы
 • Instruments pour amalgame
 • Amalgamis\instrumente

• Инструменти для амальгами
 • Instrumentos para amalgama
 • الصوك المنغم

• Ручки для скальпелей
 • Manches de bistouris
 • Skalpellgriffe

• Ручки для скальпелів
 • Mangos de bisturi
 • مشرط مقابض



DE-1230
 Fig. 10
 165mm
 English pattern



DE-1231
 Fig. 1
 185mm
 German pattern



DE-1232
 Fig. 1
 150mm
 Swiss pattern



DE-1233
 Fig. 1
 150mm



DE-1234
 Fig. 2
 150mm, 45°



DE-1235
 Fig. 3
 140mm, 90°



DE-1236
 Fig. 3
 5" (12.7cm)



DE-1237
 Fig. 3G
 5" (12.7cm)



DE-1238
 Fig. 4
 5 1/2" (13.7cm)



DE-1239
 6 Way Adjustable Angled
 Scalpel Handle



Locks At 90°, 60°, 30°,
 Straight, 120°, 150°, 180°,
 Angles

AMALGAM INSTRUMENTS



- Инструменты для амальгамы
- Instruments pour amalgame
- Amalgam-Instrumente
- Инструменти для амальгами
- Instrumentos para amalgama
- الصكوك الملقم

AMALGAM CARRIERS

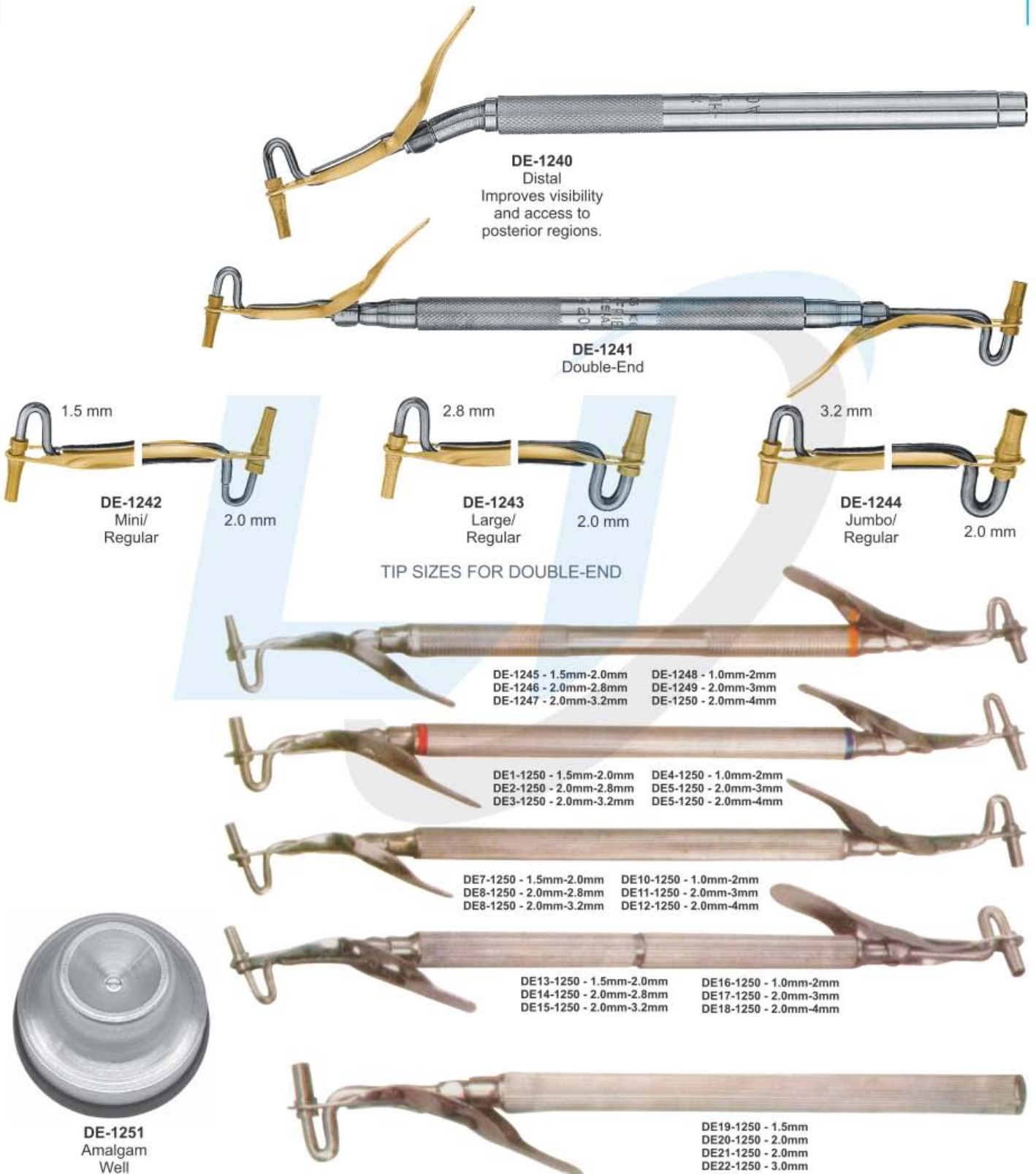

DE-1240
Distal
Improves visibility and access to posterior regions.

DE-1241
Double-End

DE-1242
Mini/
Regular

DE-1243
Large/
Regular

DE-1244
Jumbo/
Regular

TIP SIZES FOR DOUBLE-END

DE-1245 - 1.5mm-2.0mm DE-1248 - 1.0mm-2mm
DE-1246 - 2.0mm-2.8mm DE-1249 - 2.0mm-3mm
DE-1247 - 2.0mm-3.2mm DE-1250 - 2.0mm-4mm

DE1-1250 - 1.5mm-2.0mm DE4-1250 - 1.0mm-2mm
DE2-1250 - 2.0mm-2.8mm DE5-1250 - 2.0mm-3mm
DE3-1250 - 2.0mm-3.2mm DE5-1250 - 2.0mm-4mm

DE7-1250 - 1.5mm-2.0mm DE10-1250 - 1.0mm-2mm
DE8-1250 - 2.0mm-2.8mm DE11-1250 - 2.0mm-3mm
DE8-1250 - 2.0mm-3.2mm DE12-1250 - 2.0mm-4mm

DE13-1250 - 1.5mm-2.0mm DE16-1250 - 1.0mm-2mm
DE14-1250 - 2.0mm-2.8mm DE17-1250 - 2.0mm-3mm
DE15-1250 - 2.0mm-3.2mm DE18-1250 - 2.0mm-4mm

DE19-1250 - 1.5mm
DE20-1250 - 2.0mm
DE21-1250 - 2.0mm
DE22-1250 - 3.0mm

DE-1251
Amalgam
Well



ROOT PLANNING FILES



DE-1252
Krarner-Nevins
Bone Chisel



DE-1253
Krarner-Nevins
Bone Chisel



DE-1254
Molt 18.5cm
Auto Clavable
Plastic Tips.



DE-1255
Mead 18.5cm
Non Auto Clavable
Plastic Tips.



DE-1256
Miller



DE-1257
Miller

BONE FILES



DE-1258
Miller 21



DE-1259
Miller 1X
cross cut



DE-1260
Miller 2X
cross cut



DE-1261
Miller 52



DE-1262
Wahl 1



PERIODONTAL INSTRUMENTS



- Инструменты пародонтологические
- Instruments pour la parodontologie
- Instrumente für die Parodontologie
- Инструменти пародонтологічні
- Instrumentos para periodoncia
- الصكوك اللثة

PERIOSTEEL ELEVATORS

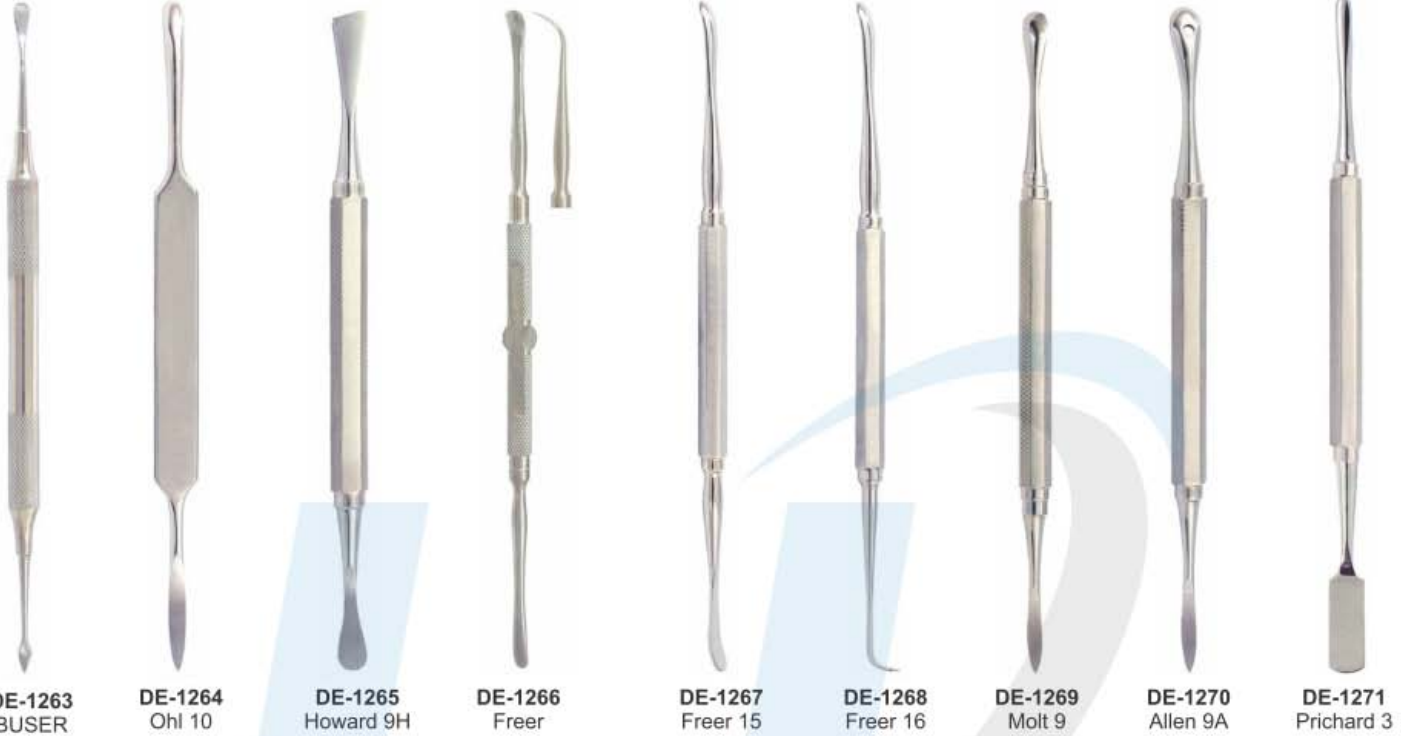

DE-1263 BUSER DE-1264 Ohi 10 DE-1265 Howard 9H DE-1266 Freer DE-1267 Freer 15 DE-1268 Freer 16 DE-1269 Molt 9 DE-1270 Allen 9A DE-1271 Prichard 3



DE-1272 Seldin 23 DE-1273 Goldman-Fox 14 DE-1274 P 24G DE-1275 Raspator, Raspatory Length 175 mm, 10.0mm DE-127A Raspator, Raspatory Length 175 mm, 6.4mm DE-127B Raspator, Raspatory Length 175 mm, 3.0mm DE-1276 Raspator, Williger Length 170 mm, different widths (4 mm, 5 mm or 7 mm), 4.0mm DE-1276A Raspator, Williger Length 170 mm, different widths (4 mm, 5 mm or 7 mm), 5.0mm DE-1276B Raspator, Williger Length 170 mm, different widths (4 mm, 5 mm or 7 mm), 7.0mm





Behind Every Smile is a Story

- QUALITY - ЯКІСТЬ
- PRECISION - ТОЧНІСТЬ
- ACCURACY - ПРАВИЛЬНІСТЬ
- DURABILITY - ЗНОСОСТІЙКІСТЬ

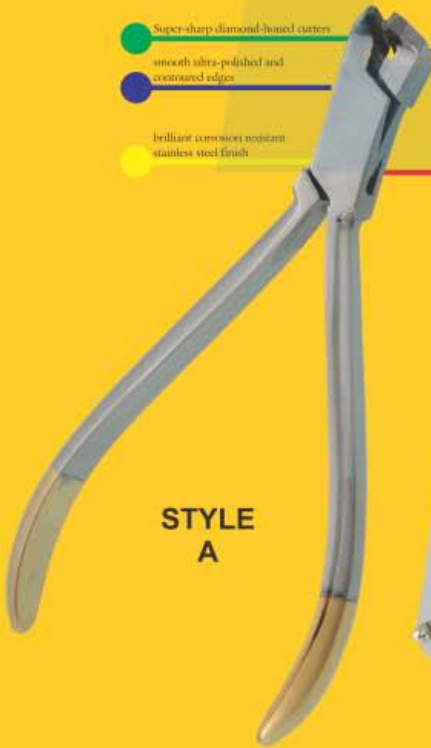

- Super-sharp diamond-boned cutters
- smooth ultra-polished and contoured edges
- brilliant corrosion resistant stainless steel finish
- superior F12 stainless steel tool inserts
- sliding lock joint for balance & precision alignment



- Super-sharp diamond-boned cutters
- smooth ultra-polished and contoured edges
- brilliant corrosion resistant stainless steel finish
- superior F12 stainless steel tool inserts
- sliding lock joint for balance & precision alignment

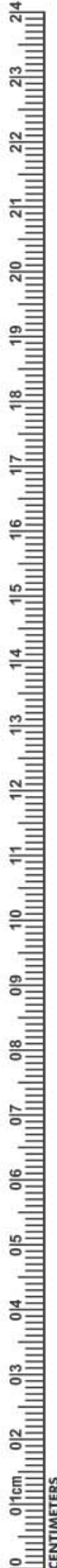

ORTHODONTIC INSTRUMENTS



- Инструменты ортодонтические
- Instrumentos Ortodonticos
- Orthodontische Instrumente
- Инструменти ортодонтични
- Instruments Orthodontiques
- أدوات تقويم الأسنان

DE-1277 Aluminum Height Gauge 0.22

DE-1278 Aluminum Height Gauge 0.18

DE1-1278 Height Gauge Movable

DE-1279 Bone Bracket Gauge

DE2-1279 Endo Finger Ruler Span Measure Scale

DE3-1279 Endo Finger Ruler Span Measure Scale

DE4-1279 Compasso De Willis

DE-1280 Bone Thickness Gauge 40mm, 180mm

DE-1281 Osteometer Measuring Forceps

DE-1282 Bracket Placer Tweezers (Extra Fine Tip)

DE-1283 Direct Bonding Bracket Holders 135mm

DE-1284 Direct Bonding Bracket Holders 136mm

DE-1285 Direct Bonding Bracket Holders 135mm

DE-1286 Deluxe Bracket Holder

DE-1287 Deluxe Bracket Holder Tweezers

DE-1288 Deluxe Bracket Holder Tweezers

DE1-1288 Bracket Tweezers Slot Aligner

DE2-1288 Direct Bonding Bracket Holders 140mm

DE3-1288 Bracket Placing Tweezes

DE4-1288 Easy Access Tweezes

DE5-1288 Direct Bonding Bracket Holders 140mm

DE6-1288 Direct Bond Bracket Holder Tweezers Small Tip

DE7-1288 Exect Brackete Holder Tweezers

DE8-1288 Easy Ecess Tweezers

DE9-1288 Slipper Tweezers



- Инструменты ортодонтические
- Instrumentos Ortodonticos
- Orthodontische Instrumente
- Инструменти ортодонтични
- Instruments Orthodontiques
- أدوات تقويم الأسنان



DE-1289
Band seater auto cleavable



DE-1290
Ortho light scaler double ended



DE-1291
Ortho light scaler double ended



DE-1292
Ortho light scaler double ended



DE-1293
Twiel-on elastic module instrument



DE-1294
Twiel-on elastic module instrument



DE-1295
Schure Band Seater



DE-1296
Ortho light scaler



DE-1297
Ortho light scaler



DE-1298
Ortho light scaler heavy



DE-1299
Ortho instrument



DE-1300
Ortho instrument



DE-1301
Ortho Light Band Pusher Scaler



ORTHODONTIC INSTRUMENTS



- Инструменты ортодонтические
- Instrumentos Ortodonticos
- Orthodontische Instrumente
- Инструменти ортодонтични
- Instruments Orthodontiques
- ادوات تقويم الأسنان



DE-1302
Ortho Light double ended
ligature director



DE-1303
Ortho Light double ended
ligature director scaler



DE-1304
Ortho Light double ended ligature scaler director tivate coil spring
are remove modules with one instruments



DE-1305
Ortho band pusher scaler



DE-1306
Ortho Light Band Pusher Scaler



DE-1307
Ortho ligature director single ended



DE-1308
Ortho Light double ended ligature
director scaler



DE-1309
Ortho Light double ended ligature scaler/director
tivate coil spring are remove modules with one instruments



DE-1310
Ortho Light double ended ligature director



DE-1311
Ortholite Ligature Director Scaler



DE-1312
Ortho light ligature director double ended



DE-1313
Double ended cement spatula



DE-1314
Ortho light scaler single ended



- Щипцы для ортодонтии и протезирования
- Pincas pour l'orthodontie et la prothèse
- Zangen für Kieferorthopädie und Prothetik
- Щипці для ортодонтії та протезування
- Alicates para ortodoncia y prótesis
- كمشة لتقويم الأسنان بروسیتیس

BOX JOINT PLIERS

DE-1315
Universal Dolphin Style
Wire Bending & cutting pliers



DE-1316 Band Removing Plier
The curved blade of the band removing plier can strip easily and gently remove directly to the tooth. Length 130mm



DE-1317
Tweed Loop forming Pliers



DE-1318
How Plier curved
Universally usable tool for the multiband technology for wires up to .028". Length 130mm



DE-1319 How Plier
Universally usable tool for the multiband technology for wires up to .028". Length 135mm



DE-1320
Nance Loop forming Pliers



DE-1321
Bracket Removing Plier curved
Bracket Removing Plier curved for easy removal of brackets in the posterior region. Length 130mm



DE-1322
Young Wire Bending & Loop Forming Pliers



DE-1323
Wire Bending & Loop Forming Pliers



DE-1324
Adams, small wire bending and loop forming Pliers



DE-1325
Bracket Removing Plier Round Box
Bracket removing plier for comfortable and quick removal of the brackets. Length 135mm



DE-1326
Weingart Plier medium
Weingart plier that are ideal due to their curved tip for setting sheets and is capable of bending the ends. Length 145mm



PLIERS FOR ORTHODONTICS & PROSTHETICS



- Щипцы для ортодонтии и протезирования
- Pincers pour l'orthodontie et la prothèse
- Zangen für Kieferorthopädie und Prothetik
- Щипці для ортодонції та протезування
- Alicates para ortodoncia y prótesis
- كماشة لتقويم الاسنان بروتیثتیس

BOX JOINT PLIERS

DE-1327 Adams Plier Round Box

Adams pliers for bending wire arches and bends right angles for wires up to .022", .025 tip to beak. Length 125mm



DE-1333 Adams Plier

Adams pliers for bending wire arches and bends right angles for wires up to .022", .025 tip to beak. Length 125mm



DE-1328

Falcon Beak Contouring Pliers.



DE-1334

Tweed Loop Formin Pliers



DE-1329

wires up to 0.020" / 0.7mm.



DE-1335 Bird Beak Plier Standard

Bird Beak Wire bending plier without notches, which is suitable as a universal utility tool. Length 125mm



DE-1330

Johnson Contouring Pliers



DE-1336

Mini Ligature cutters



DE-1331 Aderer

Large wire bending and loop forming pliers



DE-1337 Small

Fluch-cut distal and cutting Pliers with safety hold fitted with un-breakable, corrosion resistant and durable stainless steel tips



DE-1332

Tweed / angle rectangular arch forming & Torquing pliers



DE-1338 Large

Fluch-cut distal and cutting Pliers with safety hold fitted with un-breakable, corrosion resistant and durable stainless steel tips





PLIERS FOR ORTHODONTICS & PROSTHETICS

- Щипцы для ортодонтии и протезирования
- Pincers pour l'orthodontie et la prothèse
- Zangen für Kieferorthopädie und Prothetik

- Щипці для ортодонції та протезування
- Alicates para ortodoncia y prótesis
- كمشة لتقويم الأسنان بروسیتیس

BOX JOINT PLIERS

DE-1339
Tweed / Angel
1.78mm (.070") wide tips arch
forming and torquing pliers



DE-1345
Contouring Plier



DE-1340
Tweed / Angel
1.78mm (.070") wide tips arch
forming and torquing pliers



DE-1346
Bands & Crowns Plier
in order to skirt



DE-1341
Lingual / Palatal arch
forming pliers



DE-1347
Ligature Forming Pliers



DE-1342
Aderer
Facebow loop forming Pliers



DE-1348
for double back and triple back
bands in 0.30" / 0.76mm & 0.36"
/ 0.91mm lingual arch wires



DE-1343
Waldsavhs wire bending
and cutting pliers



DE-1349
Bird Beak Wire Bending
& cutting pliers



DE-1344 Aderer Plier
For the manufacturing of appliances and
activation of wires for wires up to .030" .fine
tip and up to .036" mean tip.
Length 130mm



DE-1350
Weingart Plier medium
Weingart plier that are ideal due to
their curved tip for setting sheets and
is capable of bending the ends.
Length 145mm

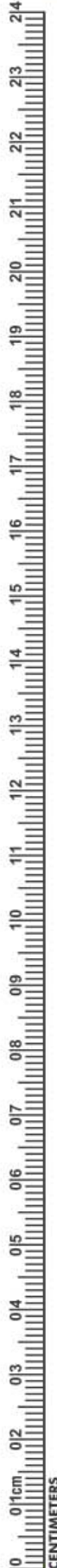

PLIERS FOR ORTHODONTICS & PROSTHETICS



- Щипцы для ортодонтии и протезирования
- Pincas pour l'orthodontie et la prothèse
- Zangen für Kieferorthopädie und Prothetik
- Щипці для ортодонції та протезування
- Alicates para ortodoncia y prótesis
- كماشة لتقويم الاسنان بروتھتیس

L-KEY JOINT PLIERS



DE-1351
Distal end cutter with safety hold, mini head, long handles.
fitted with un-breakable, corrosion resistant and durable stainless steel tips

- 0.30 mm to 0.50 mm (.012" to .020")
- Max. 0.46 mm x 0.64 mm (.018" x .025")
- ⊗ 0.38 mm to 0.53 mm (.0155" to .0215")
- ⊗ Max. 0.53 mm x 0.64 mm (.021" x .025")



DE-1355
Soft wire and ligature cutter, 15° angled fitted with un-breakable, corrosion resistant and durable stainless steel tips

- ☞ .25 mm to .38 mm (.010" to .015")



DE-1352
Flush-cut distal end cutter with safety hold fitted with un-breakable, corrosion resistant and durable stainless steel tips

- 0.30 mm to 0.50 mm (.012" to .020")
- Max. 0.46 mm x 0.64 mm (.018" to .025")



DE-1356
Soft wire and ligature cutter, 45° angled fitted with un-breakable, corrosion resistant and durable stainless steel tips

- ☞ .25 mm to .38 mm (.010" to .015")



DE-1353
Soft wire and ligature cutter, Mini fitted with un-breakable, corrosion resistant and durable stainless steel tips

- ☞ .25 mm to .38 mm (.010" to .015")



DE-1357
Hard wire cutter, straight Fitted with un-breakable, corrosion resistant and durable stainless steel tips

- 0.30 mm to 0.50 mm (.012" to .020")
- Max. 0.56 mm x 0.71 mm (.022" x .028")



DE-1354
Soft wire and ligature cutter, standard fitted with un-breakable, corrosion resistant and durable stainless steel tips

- ☞ .25 mm to .38 mm (.010" to .015")



DE-1358
Hard wire cutter, 15° angled Fitted with un-breakable, corrosion resistant and durable stainless steel tips

- 0.30 mm to 0.50 mm (.012" to .020")
- Max. 0.56 mm x 0.71 mm (.022" x .028")



DE-1359
Hard wire cutter, 15° angled Non-autoclavable

- 0.30 mm to 0.50 mm (.012" to .020")
- Max. 0.56 mm x 0.71 mm (.022" x .028")



- Щипцы для ортодонтии и протезирования
- Pincers pour l'orthodontie et la prothèse
- Zangen für Kieferorthopädie und Prothetik

- Щипці для ортодонції та протезування
- Alicates para ortodoncia y prótesis
- كمشة لتقويم الأسنان بروسیتیس

L-KEY JOINT PLIERS

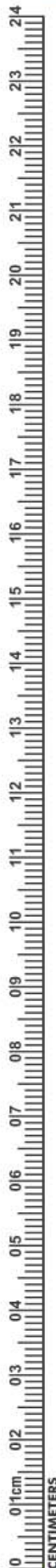

DE-1360
Band removing pliers



DE-1361
Bracket removing pliers angled



DE-1362
Bracket removing pliers straight



DE-1363
Bracket removing pliers with plastic tip



DE-1364
Adhesive removing pliers



DE-1365
Weingart-mini
Utility Pliers

- 0.30 mm to 0.50 mm (.012" to .020")
- Max 0.56 mm x 0.71 mm (.022" x .028")

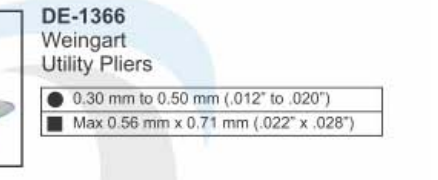

DE-1366
Weingart
Utility Pliers

- 0.30 mm to 0.50 mm (.012" to .020")
- Max 0.56 mm x 0.71 mm (.022" x .028")



DE-1367
How Straight
Utility Pliers

- 0.30 mm to 0.50 mm (.012" to .020")
- Max 0.56 mm x 0.71 mm (.022" x .028")

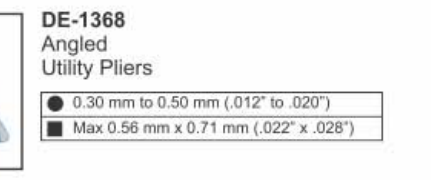

DE-1368
Angled
Utility Pliers

- 0.30 mm to 0.50 mm (.012" to .020")
- Max 0.56 mm x 0.71 mm (.022" x .028")



DE-1369
Wire bending and loop forming pliers
Angled (Bird beak)

- 0.30 mm to 0.50 mm (.012" to .020")
- Max 0.56 mm x 0.71 mm (.022" x .028")

PLIERS FOR ORTHODONTICS & PROSTHETICS



- Щипцы для ортодонтии и протезирования
- Pincers pour l'orthodontie et la prothèse
- Zangen für Kieferorthopädie und Prothetik
- Щипці для ортодонції та протезування
- Alicates para ortodoncia y prótesis
- كمشاة لتقويم الأسنان بروسيثيتيس

L-KEY JOINT PLIERS



DE-1370
Multi-purpose pliers, bird beak,
De la rosa and cutter in one

- 0.30 mm to 0.50 mm (.012" to .020")
- Max. 0.46 mm x 0.56 mm (.018" x .022")



DE-1375
Stop pliers V-Bebd - 1mm

- 0.30 mm to 0.50 mm (.012" to .020")
- Max. 0.43 mm x 0.56 mm (.017" x .028")



DE-1371
Cinch Back / tie back
Distal end bending pliers

- 0.30 mm to 0.50 mm (.012" to .020")
- Max. 0.56 mm x 0.71 mm (.022" x .028")



DE-1376
Lingual / palatal arch forming plies

- 0.76 mm (.030") / 0.91 mm (.036")



DE-1372
Hammer head
Distal end bending pliers

- 0.30 mm to 0.50 mm (.012" to .020")
- Max. 0.56 mm x 0.71 mm (.022" x .028")



DE-1377
Torquing pliers set



DE-1373
Nance
Loop forming pliers

- 0.36 mm to 0.71 mm (.014" to .028")
- Max. 0.56 mm x 0.71 mm (.022" x .028")



DE-1378
Tweed / angel
Rectangular arch forming and
torquing pliers

- 0.30 mm to 0.71 mm (.012" to .028")
- Max. 0.56 mm x 0.71 mm (.022" x .028")



DE-1374
Detailing step pliers / Bayonet
bending pliers - 1mm

- 0.30 mm to 0.50 mm (.012" to .020")
- Max. 0.56 mm x 0.71 mm (.022" x .028")



DE-1379
Surgical ball hook crimping pliers,
angled



DE-1380
Surgical ball hook crimping
pliers, straight



- Щипцы для ортодонтии и протезирования
- Pincers pour l'orthodontie et la prothèse
- Zangen für Kieferorthopädie und Prothetik

- Щипці для ортодонції та протезування
- Alicates para ortodoncia y prótesis
- كمشة لتقويم الأسنان بروسیتیس

L-KEY JOINT PLIERS



DE-1381
Aderer Clamp three jaw wire bending plier for contouring and bending wire up to .30"/.76mm.



DE-1387
Falcon beak contouring plier.

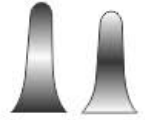

DE-1382
Bird beak plier for bending round, square and rectangle wire up to .30"/.76mm.

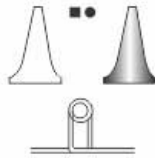

DE-1388
For placement and removal of arch wires, pins and other auxiliaries.



DE-1383
Bird beak plier for light wire bending round, square and rectangular up to .016"/0.41mm.

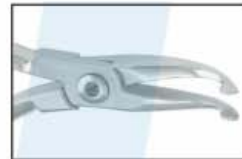
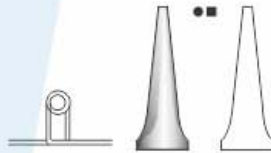

DE-1389
For placement and removal of arch wires, pins and other auxiliaries in angle design



DE-1384
Double Rounded jaw bending pliers, hooks and wire up to .020"/0.51mm.

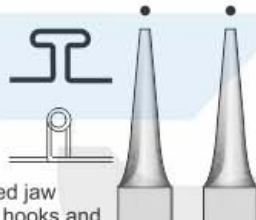

DE-1390
contouring Plier.



DE-1385
Adams pliers for hooks and bending wire up to .030"/0.76mm.

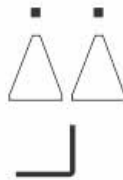

DE-1391
Bending plier. In order to skirt molares bands. With grooved. Recommended wire. 016", 018" and 022" 0.41mm, 0.46mm and 0.56mm



DE-1392
Loop forming in four length 3,4,5 & 6 mm wire capacity 0.22", 56mm.



DE-1386
Johnson pliers for crown band contouring



DE-1393
Arch bending plier design for convenient handling of square or rectangular wire, .020" / 0.51mm.



PLIERS FOR ORTHODONTICS & PROSTHETICS



- Щипцы для ортодонтии и протезирования
- Pincers pour l'orthodontie et la prothèse
- Zangen für Kieferorthopädie und Prothetik
- Щипці для ортодонції та протезування
- Alicates para ortodoncia y prótesis
- كمامشة لتقويم الاسنان بروسثیتیس

LAP & L-KEY JOINT PLIERS

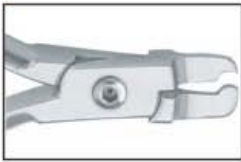

DE-1394
In order to skirt bands and crowns.



DE-1395
Wires up to .020" / 0.7mm.

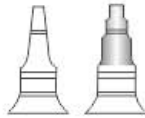

DE-1396
Round and concave plier for loop forming and banding wire up to .20" / .051mm.



DE-1397
Bending for round square or rectangular wire up to 0.30"/0.76mm



DE-1398
for double back and triple back bands in 0.30" / .76mm & 0.36" / .91mm lingual arch wires.



DE-1399
Detailing step plier double-sided offset beak permits bayonet bends. Creates right hand or left hand step-up or stepdown at 1/2, 3/4, or 1mm increments.



DE-1400
"V" bend stop special design makes 1mm "v" bends to shorten archwires or provide a positive stop. Excellent for placing stops in titanium wires. For round or rectangular wires up to .025"



DE-1401
Angle how plier efficient utility plier with serrated beaks for a firm grip. 45 angled tips to access hard to reach areas.



DE-1402
Weingardt plier serrated tips hold wires firmly at a convenient working angle. Tapered beaks fit easily between brackets and hard to reach areas. Our most popular utility plier.



DE-1415
Pin & Ligature Cutters TC.



DE-1416
Mini Pin & Ligature Cutter TC.



DE-1417
Standard Ligature Cutter TC.



DE-1418
V Bend Stop Plier TC.



DE-1419
Angled Direct Bond Bracket Remover TC.



DE1-1419
Cutter Str.



Distal Cutter
14cm
DE2-1419 2.5 mm
DE3-1419 3.0 mm
DE4-1419 3.0 mm



DE5-1419
Arrow Clasp Forming Pliers
12.0cm



DE6-1419
Schwarz
12.5cm





DISTAL END, WIRE CUTTERS & BRACKET REMOVER PLIERS

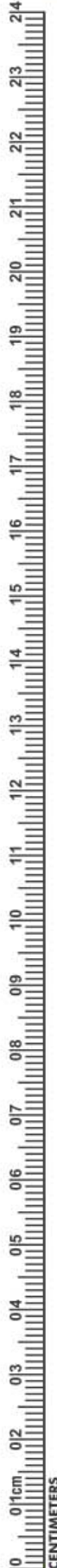

DE-1420
Distal end Cutter, Safety Hold Plier
(Ideal for Cutting Wire) TC.



DE-1421
Hook Crimping Plier Angled
Straight TC.



DE-1422
3 Prong Clasp Adjustable
Plier TC.



DE-1423
Utility Plier Weingart TC.



DE-1424
Direct Bracket Remover
TC.



DE-1425
Straight Direct Bond Bracket
Remover TC.



DE-1426
Pin Holding Plier TC.



DE-1427
Hard wire cutters



DE-1428
Elastic Separating Plier
Round Handle



DE-1429
Elastic
Separating Plier



DE-1430
DE-1431
Smaha
Elastomeric
ligature
placing forceps
140 mm



DE-1432
Elastomeric
ligature placing
forceps with
groove
Falcon 140 mm



DE-1433
Elastomeric
ligature placing
forceps with
groove
Falcon 140 mm



Normal Anatomy – Dental Implants

Bone Level Normal
(No Bone Loss)

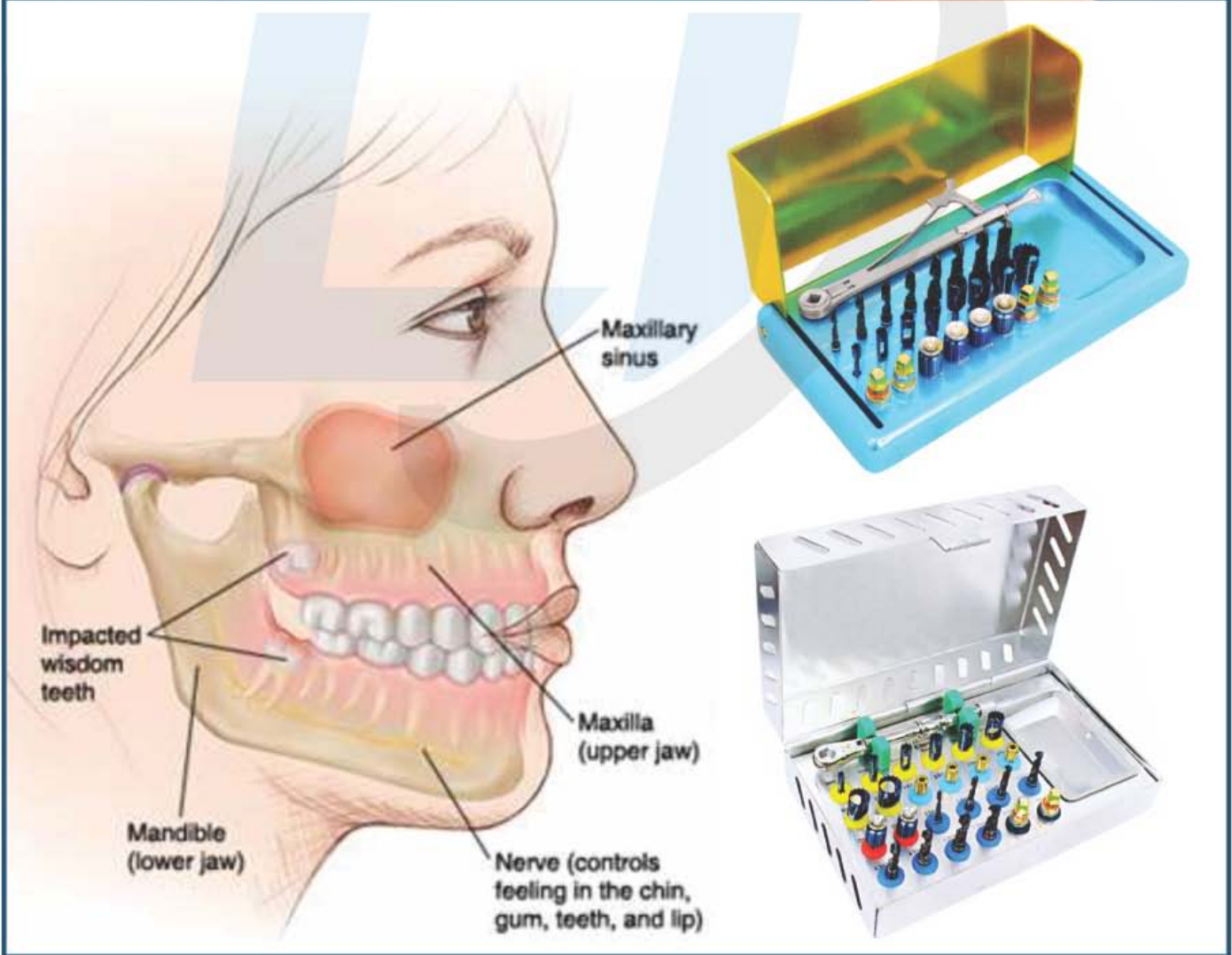
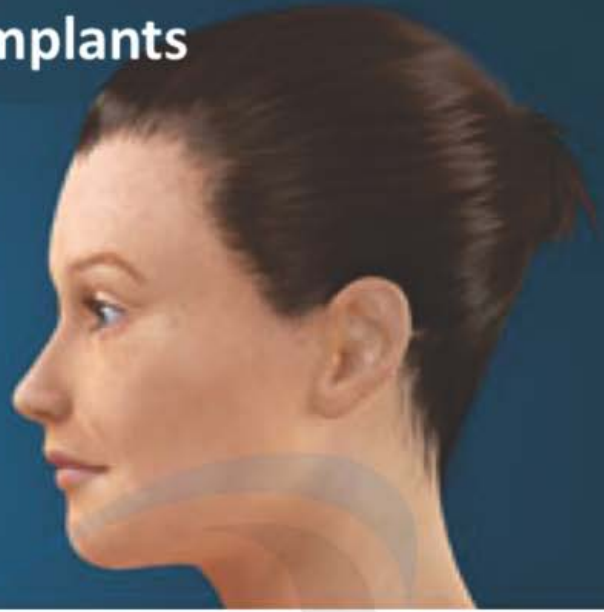
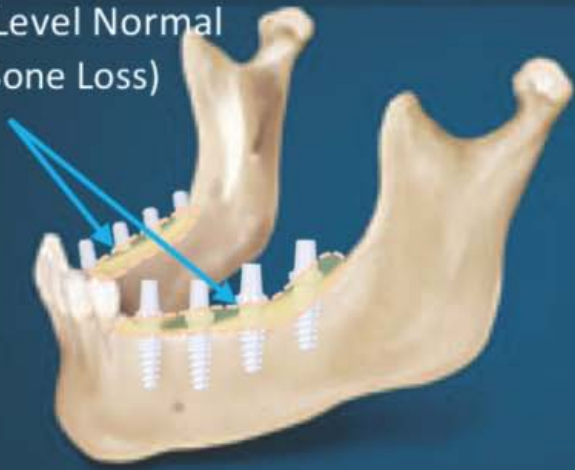

- Инструменты для имплантологии
- Implantologie
- Implantologie
- Инструменти для імплантології
- Implantologia
- زراعة الأسنان

IMPLANT GAGES



DE-1434 Multifunctional Meter
Length 90 mm, different sizes, 8-10-11mm, corrosion-resistant

DE-1435 Multifunctional Meter
Length 90 mm, different sizes, 5-13-15-17 mm, corrosion-resistant

DE-1436 Measuring Probe
Length 170 mm, hand shape or flexible (6-8-10-14-16 mm), corrosion-resistant

DE-1437

DE-1438

DE-1439

DE-1440

IMPLANT GAGES



DE-1441

DE-1442

DE-1443

0 0.1cm 0.2 0.3 0.4 0.5 0.6 0.7 0.8 0.9 1.0 1.1 1.2 1.3 1.4 1.5 1.6 1.7 1.8 1.9 2.0 2.1 2.2 2.3 2.4
CENTIMETERS

- Инструменты для имплантологии
- Implantologie
- Implantologie
- Инструменти для імплантології
- Implantologia
- زراعة الأسنان



DE-1444
Clamp, Osteometer
Length about 155 mm,
ridge width measurement,
two-sided scale,
measuring
range 0 - 25 mm



DE-1445
Measuring Loop
straight length 90 mm,
measuring range
0 - 40 mm,



DE-1446
Measuring Loop
angled, length 90 mm,
measuring range
0 - 40 mm,



DE-1447
Measuring loop, Castroviejo
angled, length 175 mm,
measuring range 0 - 40 mm,
with window



DE-1448
Boley Gauge
Stainless Steel



DE-1449
Measuring Loop
angled, length
175 mm,
measuring range
0 - 40 mm,



DE-1450
Measuring Loop
straight length
175 mm,
measuring range
0 - 40 mm,



DE-1451
Fig. 1
Iwanson
spring caliper
For metal and
porcelain.



DE-1452
Fig. 2
Iwanson
spring caliper
For wax.



DE-1453
Bone Thickness Gauge
40mm, 180mm



DE-1454
Gauge
for measuring
distances
(0 - 90 mm),



- Инструменты для имплантологии
- Implantologie
- Implantologie

- Інструменти для імплантології
- Implantologia
- زراعة الأسنان

BLACK TITANIUM COLOUR COATED INSTRUMENTS

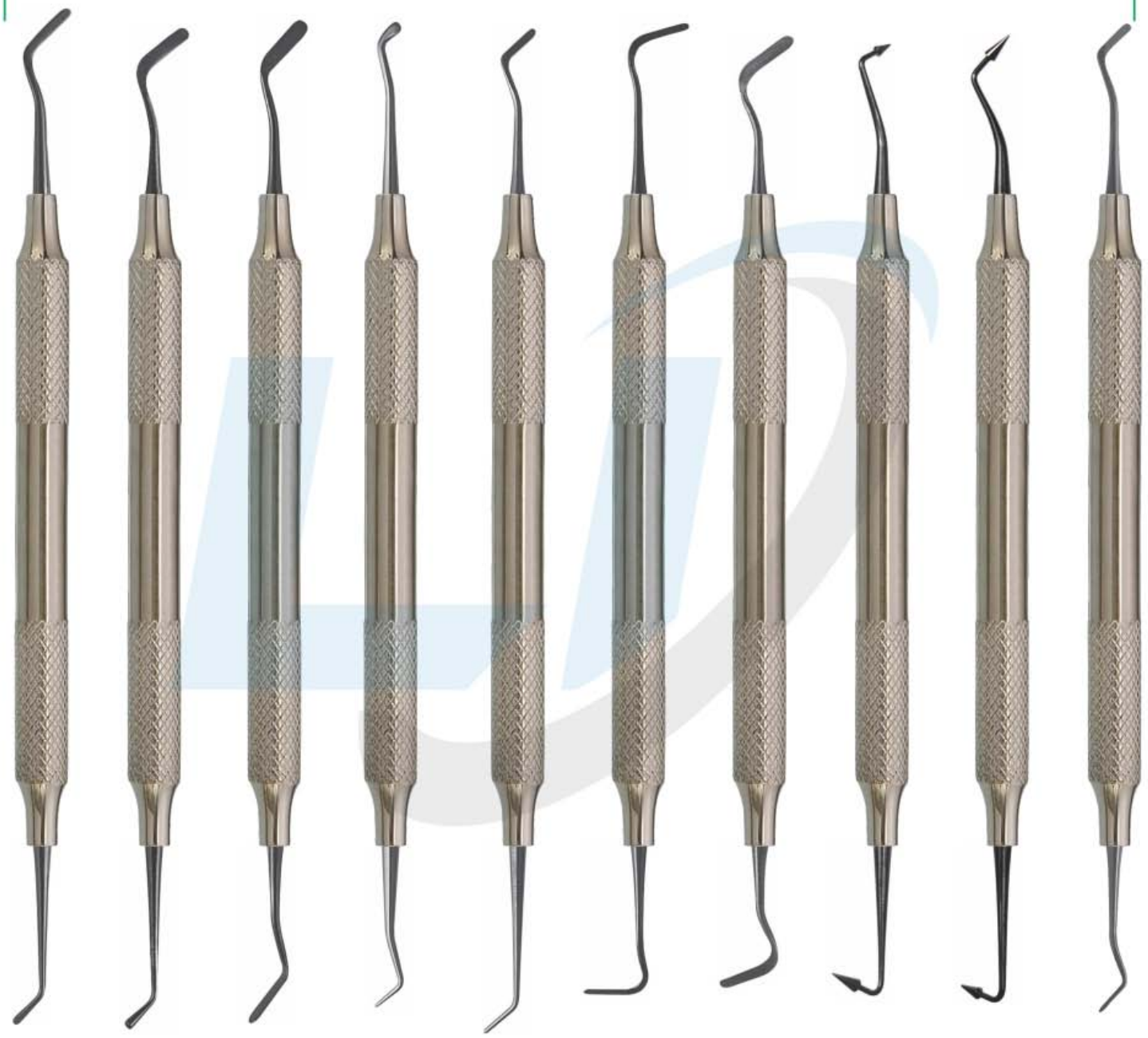

DE-1455 #1	DE-1456 #2	DE-1457 #3 Extra-Flex	DE-1458 Micro-Mini	DE-1459 Mini 1	DE-1460 Mini 4 Extra-Flex	DE-1461 #4 Extra-Flex	DE-1462 #5 Flexi-Thin	DE-1463 #6 Flexi-Thin	DE-1464 Mini 3 Extra-Flex
---------------	---------------	-----------------------------	-----------------------	-------------------	---------------------------------	-----------------------------	-----------------------------	-----------------------------	---------------------------------

- Инструменты для имплантологии
 - Implantologie
 - Implantologie
- Інструменти для імплантології
 - Implantoloia
 - زراعة الأسنان

BLACK TITANIUM COLOUR COATED INSTRUMENTS

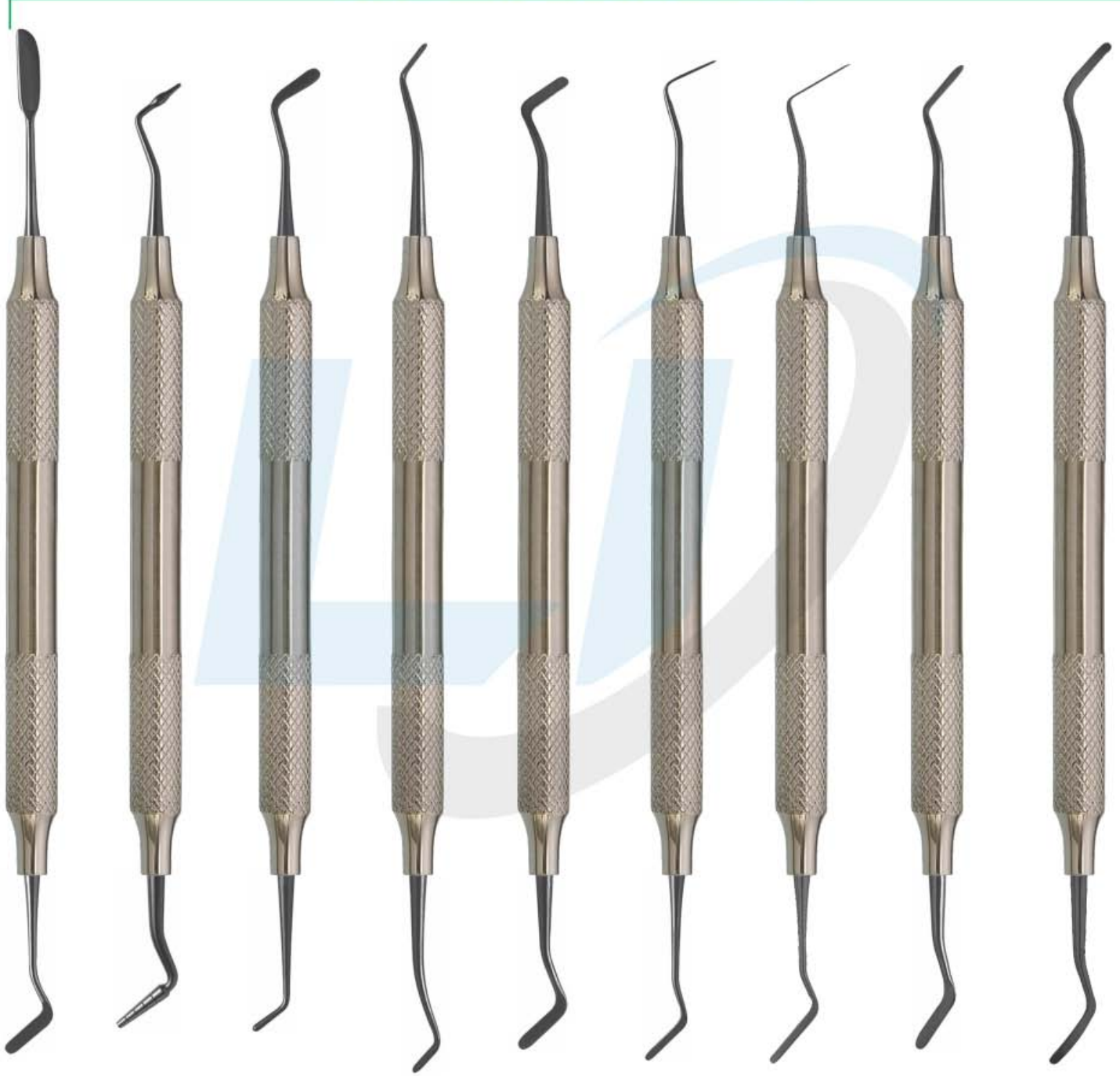

DE-1465
AB1
Boghosian

DE-1466
AB2
Boghosian

DE-1467
W3

DE-1468
8A

DE-1469
4/5
Gregg

DE-1470
Interproximal
Carver

DE-1471
Interproximal
Carver, Long

DE-1472
A6

DE-1473
Contouring
instrument

- Инструменты для имплантологии
- Implantologie
- Implantologie

- Інструменти для імплантології
- Implantologia
- زراعة الأسنان

BLACK TITANIUM COLOUR COATED INSTRUMENTS

BURNISHERS

FREEDMAN BURNISHERS

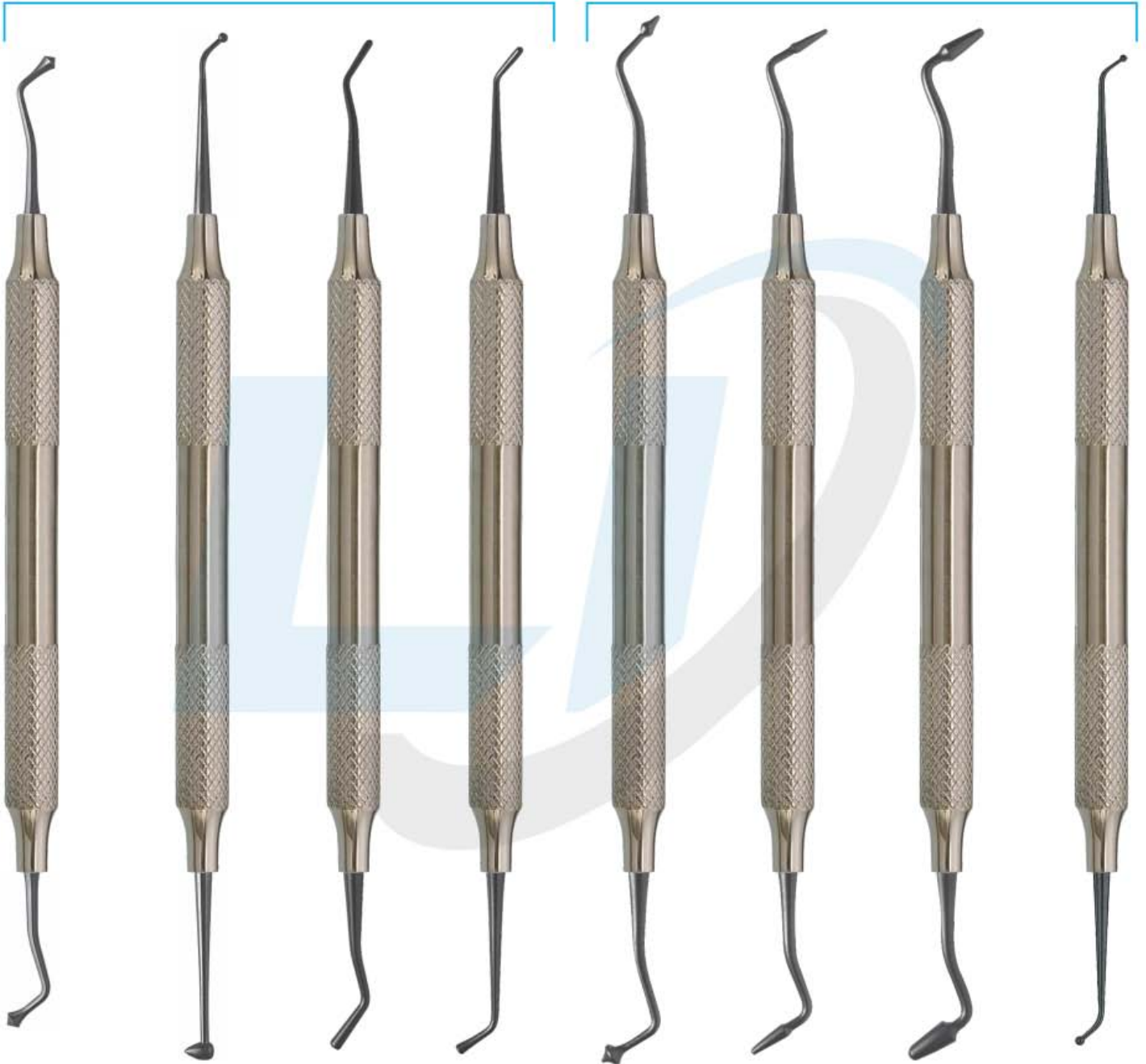

DE-1474
21B

DE-1475
27/29

DE-1476
2
Ladmore

DE-1477
3
Ladmore

DE-1478
Freedman
"Duckhead"

DE-1479
Freedman
Small Contact
Forming

DE-1480
Freedman
Large Contact
Forming

DE-1481
Small/
Medium Ball
Burnisher



- Инструменты для имплантологии
- Implantologie
- Implantologie
- Інструменти для імплантології
- Implantoloia
- زراعة الأسنان

BLACK TITANIUM COLOUR COATED INSTRUMENTS

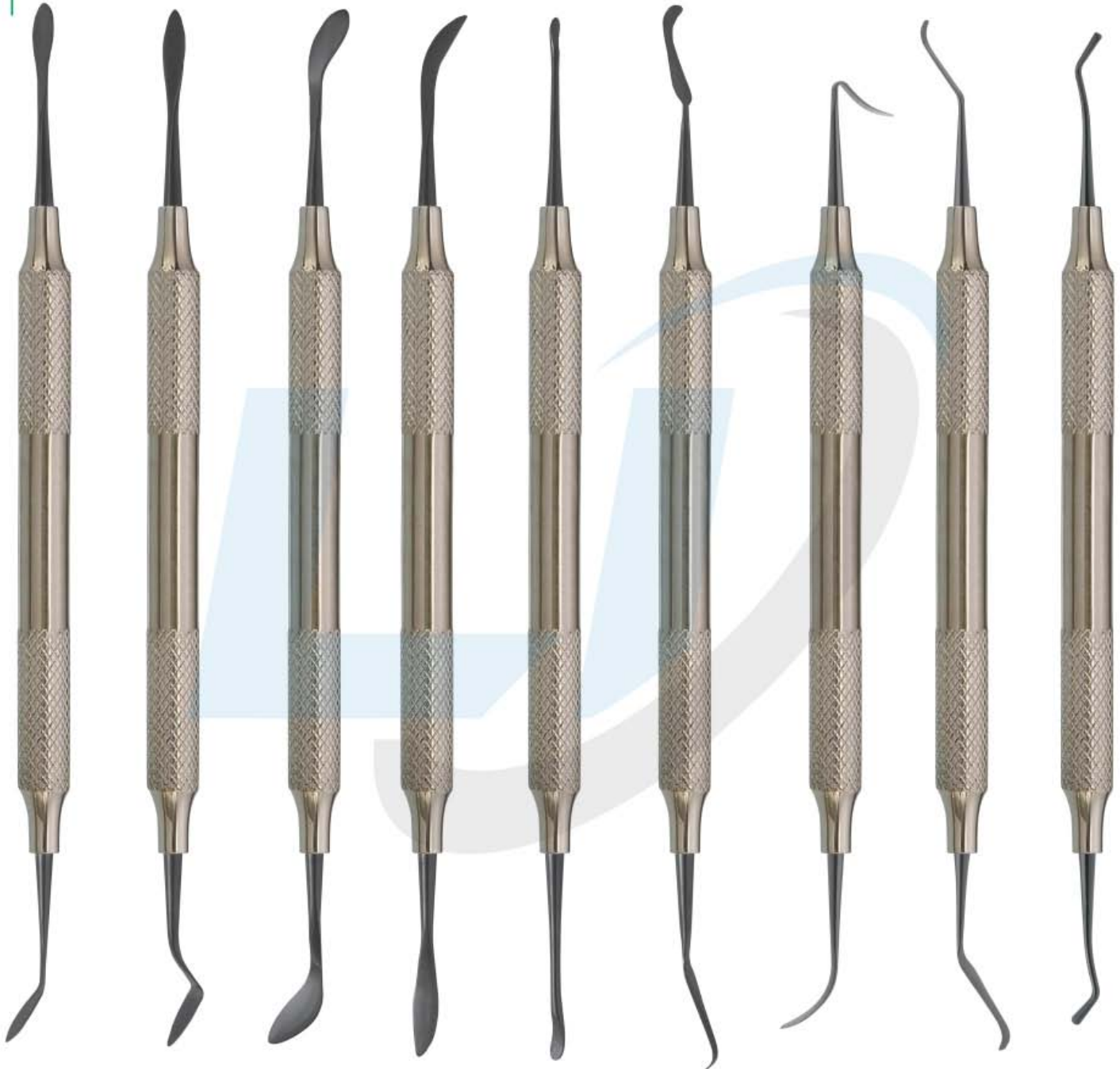

DE-1482
A
Cosmetic
Contouring

DE-1483
B
Cosmetic
Contouring

DE-1484
C
Cosmetic
Contouring

DE-1485
D
Cosmetic
Contouring

DE-1486
E
Cosmetic
Contouring

DE-1487
F
Cosmetic
Contouring

DE-1488
Marginal Ridge
& Embrasure
Shaping Instrument

DE-1489
Occlusal
Anatomy
Instrument

DE-1490
Composite
Packing
Instrument



- Инструменты для имплантологии
- Implantologie
- Implantologie

- Інструменти для імплантології
- Implantologia
- زراعة الأسنان

BLACK TITANIUM COLOUR COATED INSTRUMENTS

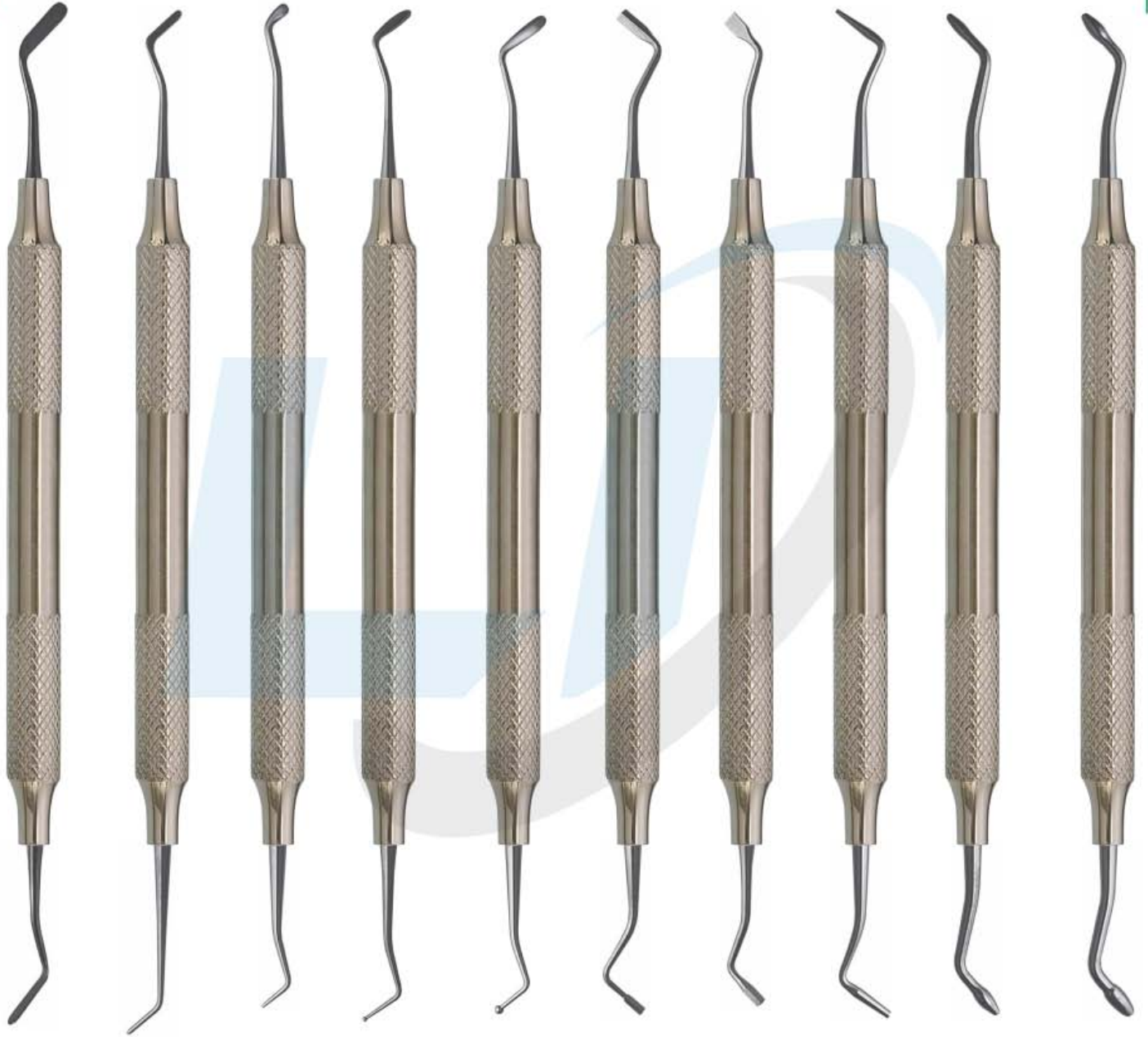
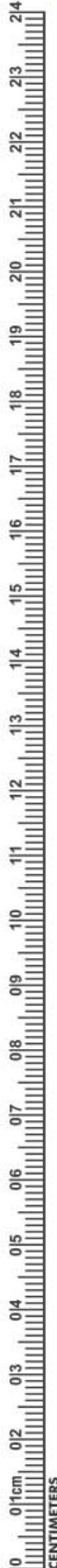

DE-1491 #3 Extra-Flex	DE-1492 Mini 1	DE-1493 Micro-Mini	DE-1494 Medium Placing/ Condensing	DE-1495 Large Placing/ Condensing	DE-1496 0T Tanner	DE-1497 3 Hollenback	DE-1498 5A	DE-1499 Small/Medium Contact Forming	DE-1500 Medium/Large Contact Forming
------------------------------------	--------------------------	------------------------------	--	---	--------------------------------	-----------------------------------	----------------------	--	--

- Инструменты для имплантологии
- Instrumenti для імплантології
- Implantologie
- Implantoloia
- زراعة الأسنان

SINUS LIFT INSTRUMENTS HOLLOW HANDLE 9.5MM LENGTH 170MM



DE-1501
Sinus Lift Elevator

DE-1502
Sinus Lift Elevator

DE-1503
Sinus Lift Elevator

DE-1504
Sinus Lift Elevator

DE-1505
Sinus Lift Elevator



- Инструменты для имплантологии
- Implantologie
- Implantologie
- Инструменти для імплантології
- Implantologia
- زراعة الأسنان

SINUS LIFT INSTRUMENTS HOLLOW HANDLE 9.5MM LENGTH 170MM



DE-1506
Sinus Lift Elevator

DE-1507
Sinus Lift Elevator

DE-1508
Sinus Lift Elevator

DE-1509
Sinus Lift Elevator



- Инструменты для имплантологии
- Implantologie
- Implantologie
- Инструменти для імплантології
- Implantologia
- زراعة الأسنان

IMPLANT SINUS LIFT INSTRUMENTS HOLLOW HANDLE 9.5MM LENGTH 170MM



DE-1510
Acute 6577

DE-1511
Sinus1

DE-1512
Sinus2

DE-1513
Sinus3,
Obtuse 6578

DE-1514
Sinus4

DE-1515
Sinus5

DE-1516
Sinus6

DE-1517
Sinus7

- Инструменты для имплантологии
 - Implantologie
 - Implantologie
- Інструменти для імплантології
 - Implantologia
 - زراعة الأسنان

SINUS LIFT INSTRUMENTS HOLLOW HANDLE 9.5MM LENGTH 170MM

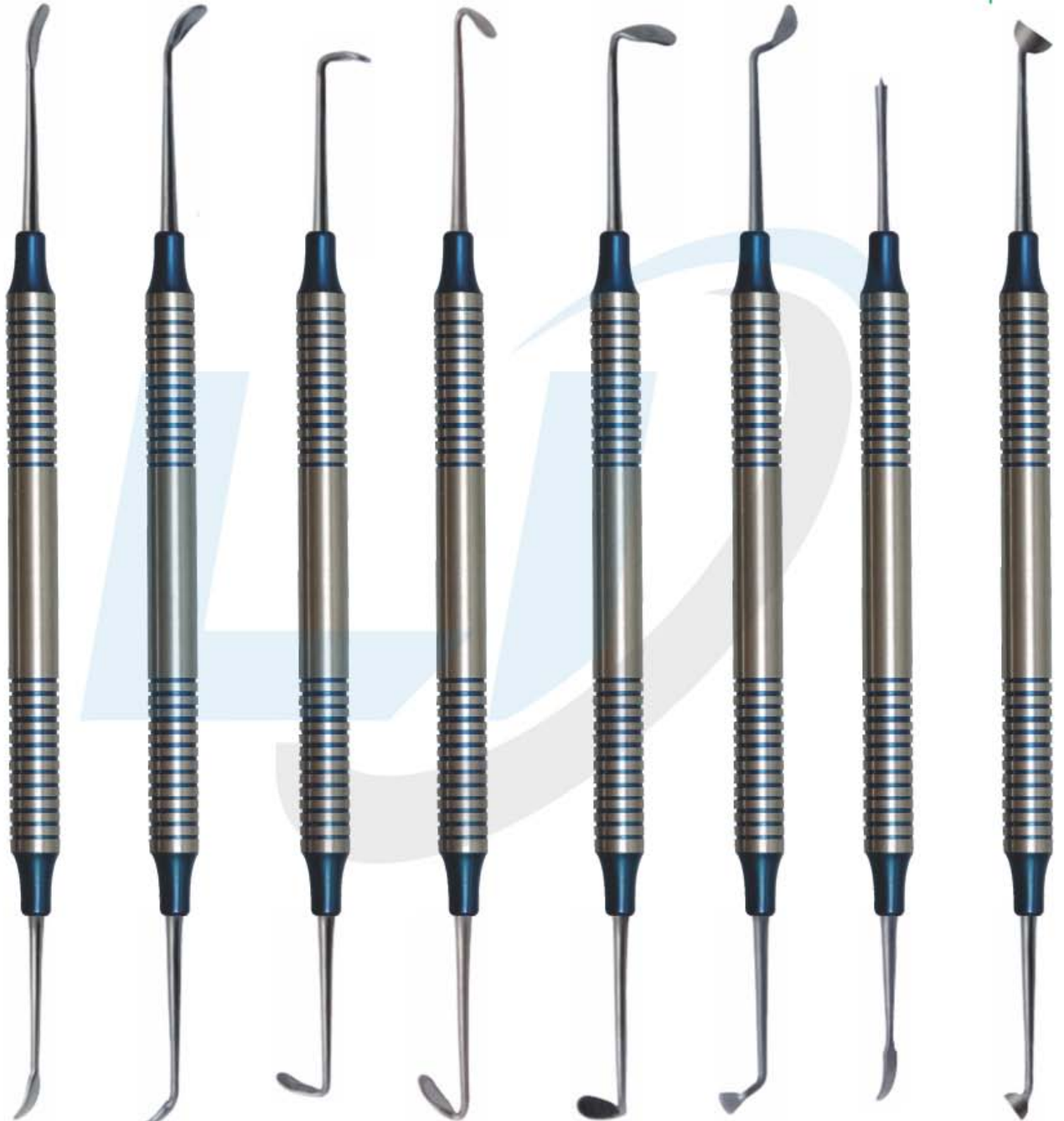
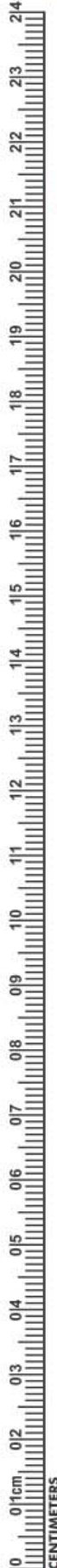

DE-1518 Sinuslift 1	DE-1519 Sinuslift 2	DE-1520 Sinuslift 3	DE-1521 Sinuslift 4	DE-1522 Sinuslift 5	DE-1523 Sinuslift 6	DE-1524 Membrane 3Positioning 1	DE-1525 Condenser 1
-------------------------------	-------------------------------	-------------------------------	-------------------------------	-------------------------------	-------------------------------	--	-------------------------------

- Инструменты для имплантологии
- Implantologie
- Implantologie

- Інструменти для імплантології
- Implantologia
- زراعة الأسنان

Sinus Lift Instrument,
Flexible Sinus Lift instruments
reduce the risk of perforation of the
"Schneider's membrane"

Sinus Lift Elevator,
10 mm Straight grip
Length 175 mm, Sinus lift elevators, dull,
for gentle peeling and lifting the
Schneider membrane

Sinus lift instrument
10 mm Straight grip Length 180 mm,
Buser (B1, B2, B3) raspatories,
quality medical stainless steel,
corrosion-resistant



DE-1526
Fig. 1

DE-1527
Fig. 2

DE-1528
Fig. 3



DE-1529
Fig. 1

DE-1530
Fig. 2

DE-1531
Fig. 3



DE-1532
B01

DE-1533
B02

DE-1534
B03



- Инструменты для имплантологии
 - Implantologie
 - Implantologie
- Інструменти для імплантології
 - Implantologia
 - زراعة الأسنان

Sinus lift instrument 10 mm Straight grip Sinus lift elevators, blunt or sharply curved
(H01, H02, K03, K04, K78, K77)

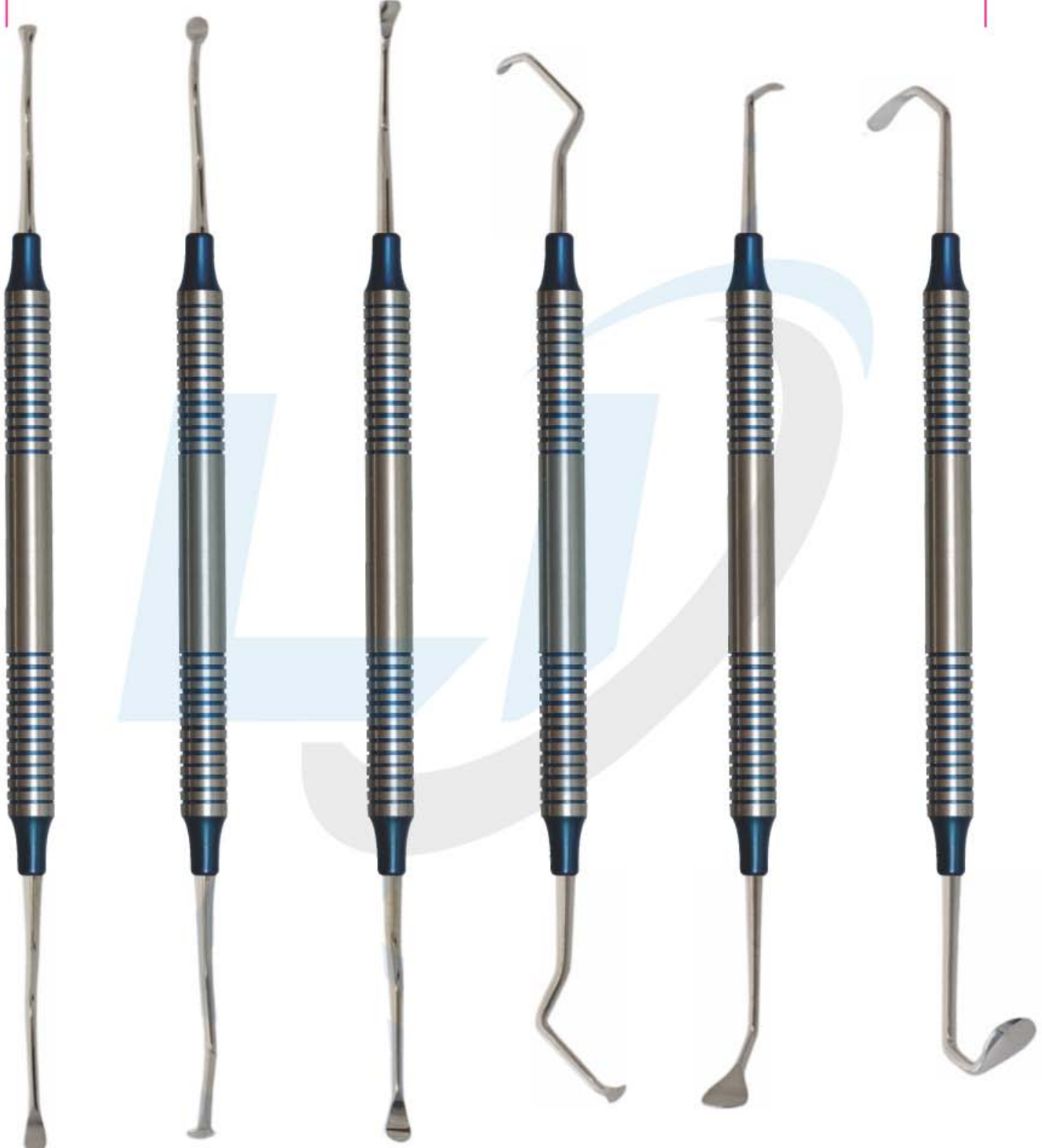

DE-1535
Sinus lift instrument
H01

DE-1536
Sinus lift instrument
H02

DE-1537
Sinus lift instrument
K03

DE-1538
Sinus lift instrument
K04

DE-1539
Sinus lift instrument
K78

DE-1540
Sinus lift instrument
K77



- Инструменты для имплантологии
- Instrumente für Implantologie
- Implantologie
- زراعة الأسنان

SINUS LIFT INSTRUMENT

Sinus Lift Elevators, 10 mm Hollow Handle length 170mm Blunt Curved Set of 6 Pcs

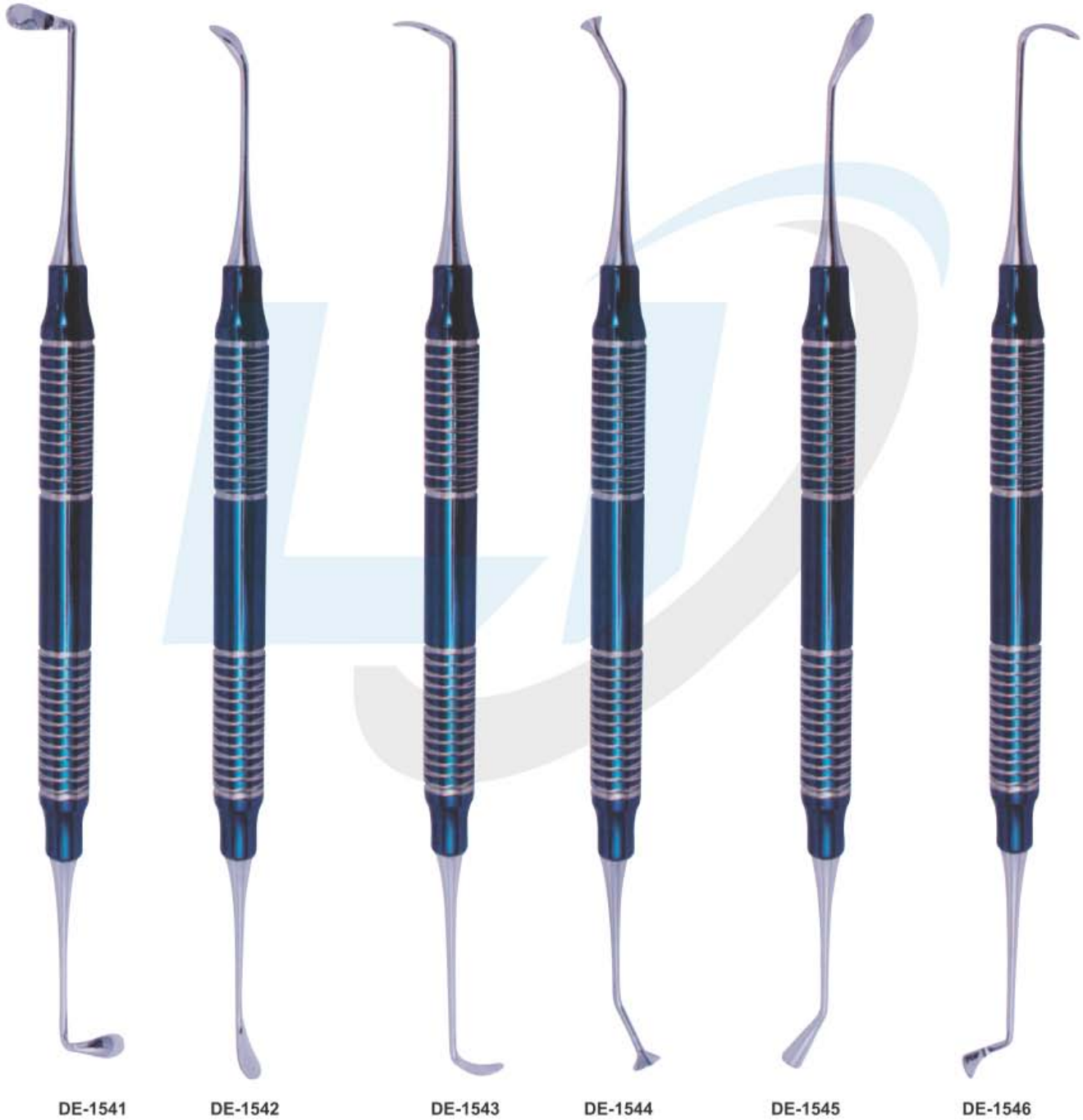

DE-1541

DE-1542

DE-1543

DE-1544

DE-1545

DE-1546

- Инструменты для имплантологии
- Implantologie
- Implantologie

- Інструменти для імплантології
- Implantologia
- زراعة الأسنان

IMPLANT SINUS LIFT INSTRUMENTS
 PERIODONTAL SURGERY SURGICAL CHISELS
 KRAMER NEVINS SINUS LIFT

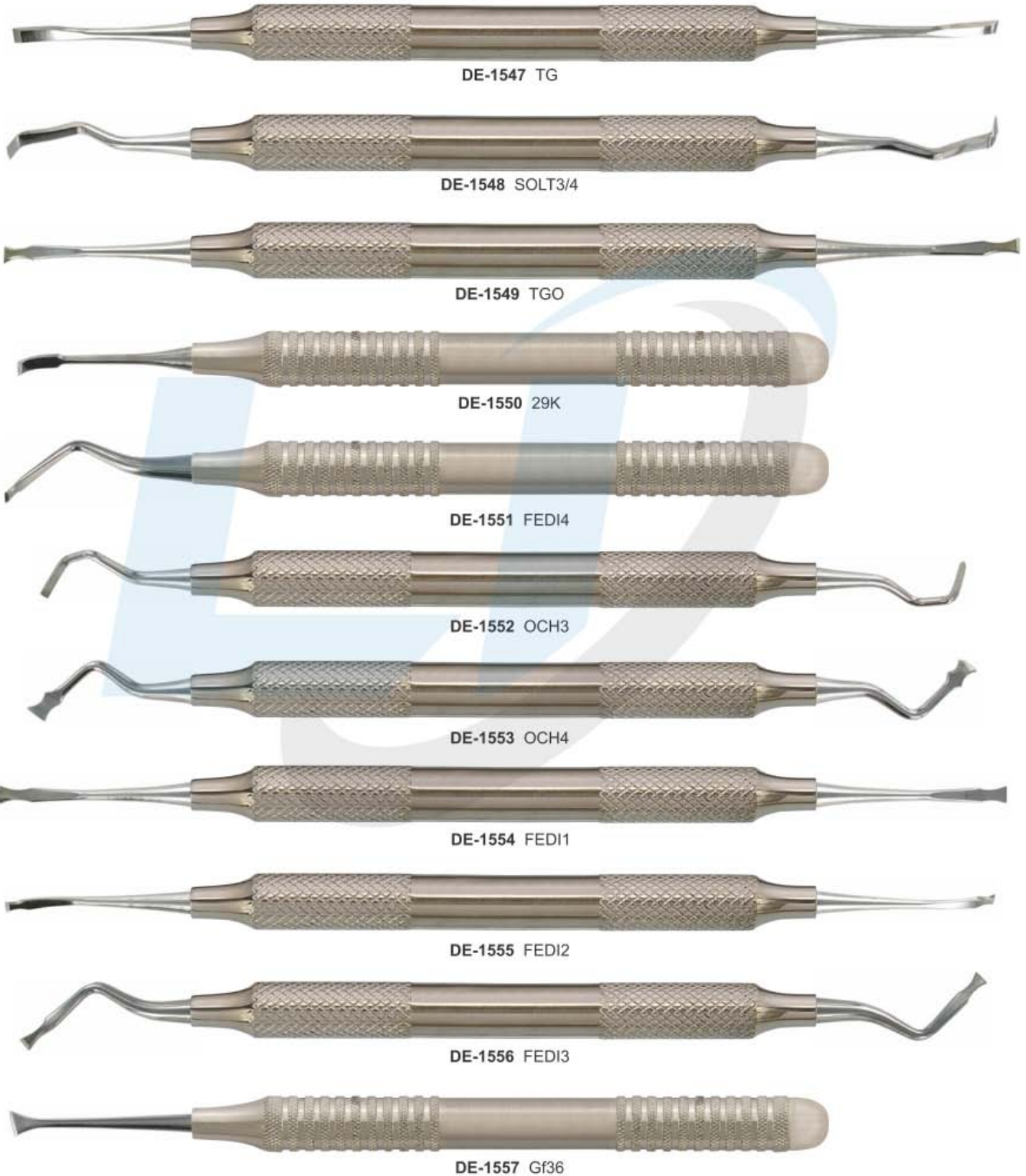

IMPLANTOLOGY



- Инструменты для имплантологии
- Implantologie
- Implantologie

- Інструменти для імплантології
- Implantoloia
- زراعة الأسنان

IMPLANT

SURGICAL CHISELS



3.5mm

DE-1558 13K/TG

3mm

3.5mm

DE-1559 13K/TG Titanium

3mm

3.5mm

DE-1560 13K/TG

4.5mm

3.5mm

DE-1561 13KL/R Titanium

4.5mm

4mm

DE-1562 13KL 4/6mm
Titanium Available

6mm

DE-1563 Pt2 Titanium
A/V Regular

DE-1564 Pt1 Titanium
A/V Regular

DE-1565 Pt3 Titanium Angel S/E

DE-1566 Pt4 Titanium STR S/E

DE-1567 Pt5 Titanium TG CVD S/E

- Инструменты для имплантологии
- Implantologie
- Implantologie

- Інструменти для імплантології
- Implantologia
- زراعة الأسنان

MIXING SPATULA WITH SHOVEL



DE-1568
Bone Carrier
Titanium



DE-1569
Raspator, Prichard
Length 180 mm,
10 mm hollow handle,
double-ended
10.5 mm | 4.5 mm,



DE-1570
Raspator, Prichard
Length 180 mm,
10 mm hollow handle,
double ended



DE-1571
Raspator, Prichard
Length 180 mm,
10 mm hollow handle,
double-ended
10.5 mm | 4.5 mm,



DE-1572
Mixing Spatula
with shovel
17cm



DE-1573
Mixing Spatula
with shovel
18.5cm



- Инструменты для имплантологии
- Implantologie
- Implantologie
- Инструменти для імплантології
- Implantologia
- زراعة الأسنان

BONE GRAFTING INSTRUMENTS COMPACTOR /TAMPERS

Product offering includes instruments for harvesting, mixing and compacting bone Provides clinicians with the proper instrumentation for bone grafting procedures Weighted bone basin Prevents tipping and spilling of bone and other materials during mixing



DE-1574
Graft Packer,
Concave Tips
DE 4/6mm

DE-1575
Bone Spoon/
Packer DE 3mm

DE-1576
Graft Packer,
Serrated Tips
DE 6/8mm

DE-1577
Graft Packer,
Serrated Tips
DE 3/4mm

DE-1578
Graft Packer,
Smooth Tips
DE 5/8mm

DE-1579
Titanium graft packer/
placement site depth
gauge 3.3mm & 4.0mm
Diameter tips Marked
at 8, 11, 13, 15 & 18mm

DE-1580
Graft Material Spoon
Concave Tip For
Larger Grafts

- Инструменты для имплантологии
- Implantologie
- Implantologie

- Інструменти для імплантології
- Implantologia
- زراعة الأسنان

BONE GRAFTING INSTRUMENTS

**DE-1581
Blade and pusher**
Length 180 mm,
for straight or angled,
blade: 15 x 5 mm,
pusher: 4 mm diameter
Straight



**DE-1582
Blade and pusher**
Length 180 mm,
for straight or angled,
blade: 15 x 5 mm,
pusher: 4 mm diameter
angular



**DE-1583
Spoon and pusher**
Length 180 mm,
for angled spoon:
10 x 5 mm, pusher:
diameter 3 mm



**DE-1584
Tunnelierungs
Instrument**
length 175 mm,



**DE-1585
Tunnelierungs
Instrument**
length 175 mm,
different designs



**DE-1586
Tampers**
Length 170 mm,
for bone material,
double-ended,
diameter 3.2 mm
(2-4-6-8-10) and diameter
2.5mm (2-4-6-8-10)

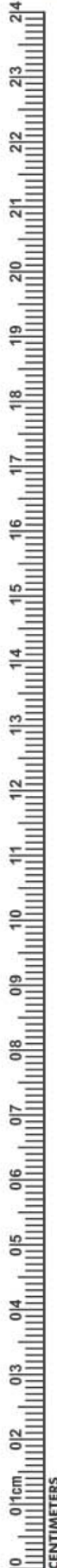

- Инструменты для имплантологии
- Implantologie
- Implantologie
- Инструменти для імплантології
- Implantologia
- زراعة الأسنان

Pluggers Clarizio

Length 160 mm, with titanium tips for mixing and pouring of autologous, heterologous bone substitute material, diameter (3/4 or 6/8 mm)

BONE GRAFTING INSTRUMENTS



DE-1587 Ø 4mm
DE-1588 Ø 5mm
Compactor
150mm



DE-1589
Sinus Window
Bone Tampers
4 mm



DE-1590
Sinus Window
Bone Tampers
7 mm



DE-1591
6/8mm



DE-1592
3/4mm



- Инструменты для имплантологии
- Implantologie
- Имплантология
- Інструменти для імплантології
- Implantologia
- زراعة الأسنان

SPOON AND PUSHER (TRINOVO)

Trinovo handle, different workers, for bone material, high-grade medical stainless steel, corrosion-resistant



DE-1593
10x5mm

Spoon and Pusher
with safety stop

DE-1594
10x5mm

Spoon and Pusher
with safety stop

DE-1595
10x5mm

Spoon and Pusher
with safety stop

DE-1596
Bone Graft/Carrier
Titanium
2-4-6-8-10mm

DE-1597
15x10mm

Spoon and Pusher
with safety stop

DE-1598
10x5mm

Spoon and Pusher
with safety stop

DE-1599
10x5mm

Spoon and Pusher
with safety stop

- Инструменты для имплантологии
- Implantologie
- Implantologie
- Інструменти для імплантології
- Implantoloia
- زراعة الأسنان

PERIOSTEALS ELEVATOR 10mm Hollow Handle



DE-1600
Raspator,
BonexScraper
Length 165 mm,
10 mm hollow
handle,
double-ended 6
mm / 4 mm,

DE-1601
Raspator,
Raspatory
Length 180 mm,
10 mm hollow
handle,
double-ended
3 mm | 3 mm,

DE-1602
Raspator,
Raspatory
Length 180 mm,
10 mm hollow
handle,
double-ended
3 mm | 3 mm,

DE-1603
Raspator,
Papilla
Length 185 mm,
10 mm hollow
handle,
double-ended
3 mm | 2 mm,

DE-1604
Raspator,
bone scraper
Length 175 mm,
10 mm hollow
handle,
double-ended,

DE-1605
Raspator,
micro-Freer
Length 180 mm,
6 mm solid grip,
double-ended
3 mm | 4 mm

DE-1606
Raspator,
Freer
Length 180 mm,
6 mm solid
handle,
double-ended
5 mm | 5 mm,

- Инструменты для имплантологии
- Implantologie
- Implantologie

- Інструменти для імплантології
- Implantologia
- زراعة الأسنان

PERIOSTEALS ELEVATOR 10mm Hollow Handle

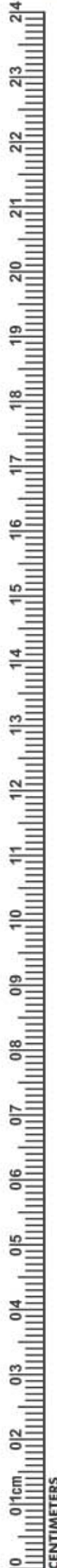

DE-1607
Raspator,
Freer
10 mm hollow
handle,
high-quality
medical
double ended

DE-1608
Raspator,
Molt
Length 180 mm,
8 mm solid
grip,
double-ended
6 mm

DE-1609
Raspator,
micro Freer
Length 185 mm,
10 mm hollow
handle,
double-ended,

DE-1610
Raspator,
micro Freer
Length 185 mm,
10 mm hollow
handle,
double-ended,

DE-1611
Raspator, micro
Raspator /
chisel
Length 170 mm,
10 mm hollow
handle,
double-ended,

DE-1612
Raspator, micro
Raspator /
chisel
Length 175 mm,
10 mm hollow
handle,
double-ended,

DE-1613
Raspator,
Micro Raspator /
chisel
Length 175 mm,
8 mm solid handle,
double-ended
3.5mm | 3.5 mm,

- Инструменты для имплантологии
- Implantologie
- Implantologie
- Інструменти для імплантології
- Implantoloia
- زراعة الأسنان

PERIOSTEALS ELEVATOR 10mm Hollow Handle



DE-1614
Raspatory Micro Molt
Length 175 mm,
corrosion-resistant

DE-1615
Raspatory Chipping
Workers:
Chisel 24G and 7.5 mm,
length about 175 mm,
corrosion-resistant

DE-1616
Raspatory MOLT
Work ends:
5.0 mm and 4.0 mm,
length about 175 mm,
corrosion-resistant

DE-1617
Rasp, Molt M9
Length 175 mm,
corrosion-resistant

DE-1618
Raspator, WAUTIER
Length 175 mm,
corrosion-resistant

DE-1619
Raspator, BENQUE
Length 170 mm,
workers
5 mm | 7 mm,
corrosion-resistant

DE-1620
Raspator, Nordberg
Length 180 mm,
8 mm hollow handle,
double-ended
6 mm | 4 mm

- Инструменты для имплантологии
- Implantologie
- Implantologie

- Інструменти для імплантології
- Implantologia
- زراعة الأسنان

Hollow Handle 10mm Length 170mm

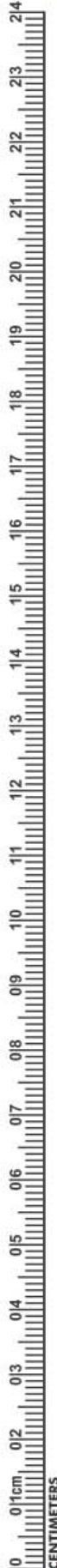

- Инструменты для имплантологии
- Implantologie
- Implantologie
- Инструменти для імплантології
- Implantoloia
- زراعة الأسنان

TISSUE MEMBRANE FORCEPS



DE-1630
Tissue Graft Forcep
Serrated Teeth



DE-1631
Self Locking
Grooved



DE-1632
Tissue Graft Forcep
Serrated Teeth



DE-1633
Titanium
Locking Plier



DE-1634
TC Gripper Carbide
Tipped Tissue Forceps
Serrated Carbide Tips
14.5cm



DE-1635
Adson Carbide
Tipped Tissue Forceps
Serrated Carbide Tips
12cm



DE-1636
Micor Adson 1x2
Tissue Forcep 12.1cm
1x2 Teeth - 0.5mm Tips



DE-1637
Adson 7x7
Tissue Forceps
7x7 Teeth 12cm



DE-1638
Adson 7x7 Curved
Tissue Forceps
7x7 Teeth 12cm



DE-1639
Suture Pliers
Suture Forceps with
1.6mm Ring Tip



DE-1640
Debakey Atraumatic
Tissue Forceps Straight
Serrated Teeth
16cm



DE-1641
Debakey Atraumatic
Tissue Forceps Curved
Serrated Teeth
16cm



- Инструменты для имплантологии
- Implantologie
- Implantologie

- Інструменти для імплантології
- Implantologia
- زراعة الأسنان

TISSUE MEMBRANE FORCEPS



DE-1642
Russian Long
Tissue Forceps
Serrated Tip
20cm



DE-1643
Russian
Tissue Forceps
Serrated Tip
15cm



DE-1644
Tissue Punch Forceps
To Remove Tissue
After Using Punch



DE-1645
13.5 cm
narrow



DE-1646
10.5 cm
Membrane tweezers KUEHNE



DE-1647
13.5 cm
wide



DE-1648
Pin-Tweezers
with or without lock,
length 15 cm,
with lock



DE-1649
without lock,



DE-1650
Haltepinzette with lock
15,5 cm, for pins, towards
the tips, etc.,



DE-1651
Carry Forceps
15cm



DE-1652
Carry Forceps
15cm



DE-1653
Carry Forceps
15cm



- Инструменты для имплантологии
- Implantologie
- Implantologie
- Инструменти для імплантології
- Implantoloia
- زراعة الأسنان

OSTEOTOME CONVEXES / CONCAVE / CONIQUES

CONVEXES

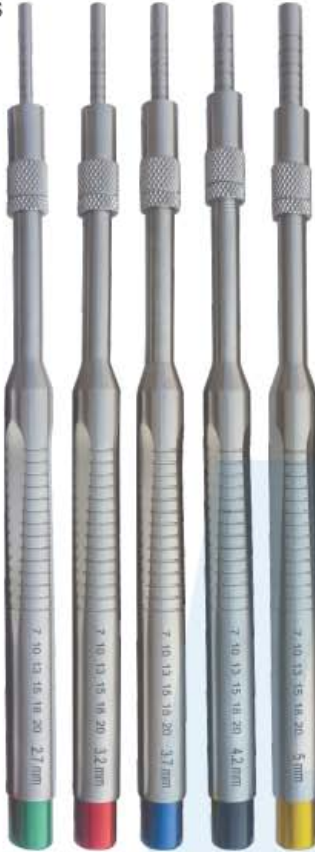

DE-1654
SET OF 5 PIECES

CONCAVES

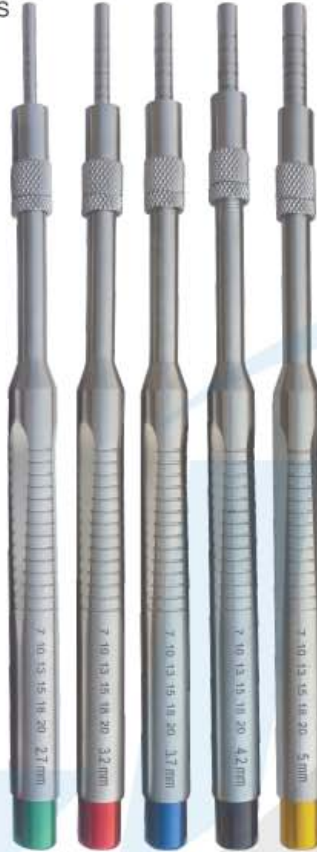

DE-1655
SET OF 5 PIECES

CONIQUES



DE-1656
SET OF 5 PIECES

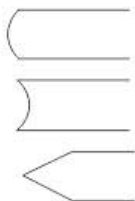
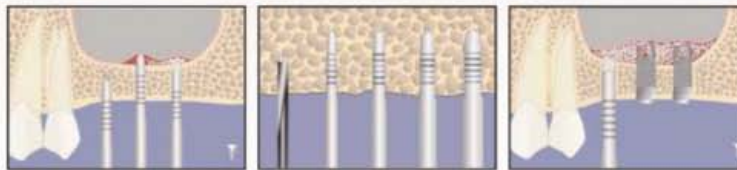

CONVEXES STRAIGHT	DE-1654	2,7 Ømm	3,2 Ømm	3,7 Ømm	4,2 Ømm	5 Ømm
CONCAVES STRAIGHT	DE-1655	2,7 Ømm	3,2 Ømm	3,7 Ømm	4,2 Ømm	5 Ømm
CONIQUES STRAIGHT	DE-1656	2,7 Ømm	3,2 Ømm	3,7 Ømm	4,2 Ømm	5 Ømm

- Инструменты для имплантологии
- Implantologie
- Implantsologie
- Инструменти для імплантології
- Implantologia
- زراعة الأسنان

OSTEOTOME CONVEXES / CONCAVE / CONIQUES

CONVEXES



DE-1657
SET OF 5 PIECES

CONCAVES



DE-1658
SET OF 5 PIECES

CONIQUES



DE-1659
SET OF 5 PIECES

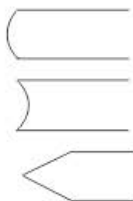
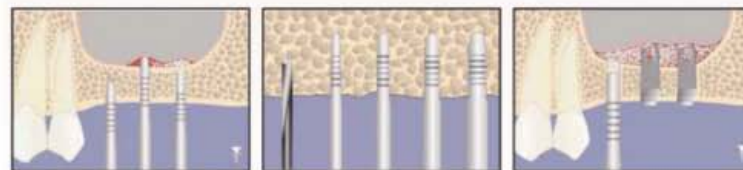

CONVEXES CURVED	DE-1657	2,7 Ømm	3,2 Ømm	3,7 Ømm	4,2 Ømm	5 Ømm
CONCAVES CURVED	DE-1658	2,7 Ømm	3,2 Ømm	3,7 Ømm	4,2 Ømm	5 Ømm
CONIQUES CURVED	DE-1659	2,7 Ømm	3,2 Ømm	3,7 Ømm	4,2 Ømm	5 Ømm

IMPLANTOLOGY



- Инструменты для имплантологии
- Implantologie
- Implantologie

- Інструменти для імплантології
- Implantologia
- زراعة الأسنان

TREPHINE

Burs with depth markings are suited for precise and simple transplantation of cylindrical bone grafts as well as for all other bone-extraction tasks.



DE-1669
Tissue Punch with pin
Set of Four Pieces



DE-1670
Tissue Punch
Set of Five Pieces



DE-1671
Tissue Punch
Set of Five Pieces



DE-1672
Trephine Drill
Set of Eight Pieces



DE-1673
Short Implant Drills

DE-1674
Long Implant Drills



DE-1675
Trephine Drill
Set of Eight Pieces



- Инструменты для имплантологии
- Implantologie
- Implantologie

- Інструменти для імплантології
- Implantologia
- زراعة الأسنان

BONE SCRAPER STRAIGHT & CURVED



DE-1676
Bone Scraper
Straight



DE-1677
Bone Scraper
Curved

TISSUE PUNCH STRAIGHT & CURVED



DE-1678
Tissue Punch
Straight



DE-1685
Tissue Punch
Curved

- DE-1679 2.0mm
- DE-1681 5.0mm
- DE-1683 7.0mm

- DE-1680 4.0mm
- DE-1682 6.0mm
- DE-1684 8.0mm

- DE-1686 2.0mm
- DE-1688 5.0mm
- DE-1690 7.0mm

- DE-1687 4.0mm
- DE-1689 6.0mm
- DE-1691 8.0mm



DE-1692
Bone Mill



DE-1693
Basins For Bone



BONE CRUSHER
DE-1694

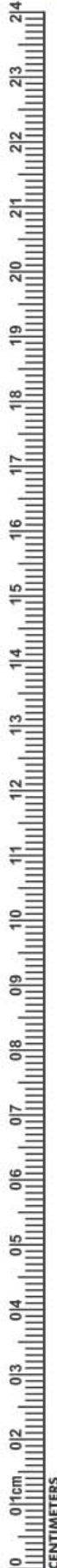

- Инструменты для имплантологии
- Implantologie
- Implantologie
- Инструменти для імплантології
- Implantologia
- زراعة الأسنان

KEYS FOR IMPLANT SCREW



DE-1695



DE-1696



DE-1697



DE-1698

TORQUE WRENCH & RATCHET



DE-1699 Star Torque Wrench 6.35mm Universal



DE-1700 Round Torque Wrench 4.0mm Universal



DE-1701 Hex Driver With 4.0mm Driver



DE-1702 Star Torque Wrench 6.35mm Universal



DE-1703 Hex Torque Wrench 4.00mm Universal



DE-1704 Star Torque Wrench 6.35mm Universal



DE-1705 Star Torque Wrench 6.35mm Universal



DE-1706 Star Torque Wrench 6.35mm Universal



DE-1707 Star Torque Wrench 6.35mm Universal



DE-1708 Star Torque Wrench 6.35mm Universal



DE-1709 Star Ratchet Wrench 6.35mm Universal



DE-1710 Star Ratchet Wrench 6.35mm Universal



DE-1711 Star Ratchet Wrench 6.35mm Universal



DE-1712 Star Ratchet Wrench 4.0mm Universal



DE-1713 Round Ratchet Wrench 4.0mm Universal



DE-1714 Round Ratchet Wrench 3.35mm Universal



DE-1715 Star Ratchet Wrench 4.0mm Universal



DE-1716 Star Ratchet Wrench 6.35mm Universal



- Инструменты для имплантологии
- Implantologie
- Implantologie

- Інструменти для імплантології
- Implantologia
- زراعة الأسنان

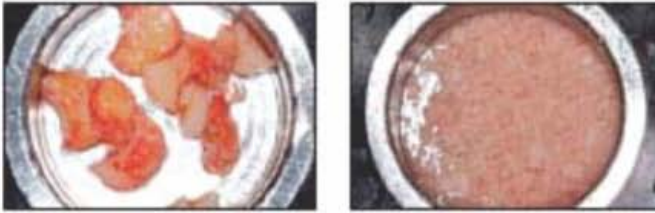

**DE-1717
BONE CRUSHER**
Titanium Metal Cutter

mallet



**DE-1718
BONE CRUSHER**
Titanium Metal Cutter

mallet



**DE-1719
BONE CRUSHER**



**DE-1720
BONE CRUSHER**
Bone Grinding Grain
1.5mm, 2mm, 2.5mm



**DE-1721
BONE CRUSHER**
Bone Grinding Grain
1.5mm, 2mm, 2.5mm



- Инструменты для имплантологии
- Implantologie
- Implantologie
- Инструменти для імплантології
- Implantologia
- زراعة الأسنان

BONE EXPANDER SCREW & SURGICAL KITS



DE-1722
 Bone Universal Kit
 Drill: 2mm, 2.8mm, 3.2mm, 3.65mm,
 4.2mm, 4.5mm, 4.8mm, 5.2mm
 Trephines Bit:
 3.0mm, 4.0mm, 5.0mm, 6.0mm,
 7.0mm, 8.0mm, 9.0mm, 10mm.
 Driver:
 2.5mm, 2.5mm Hand Pcs
 1.25mm, 1.25mm Hand Pcs
 Short Driver 2.5mm
 Long Driver 2.5mm
 1.25mm, Short Hex Driver Hand Pcs
 1.25mm, Long Hex Driver Hand Pcs
 Torque Wrench 4.0mm



DE-1723
 Bone Expander Kit
 Expander: 2.6mm, 3.0mm,
 3.4mm, 3.8mm, 4.3mm
 Ratchet Driver
 Parallel Pin
 Pilot Drill
 Drill 1.4mm
 Drill Driver 4mm
 Hand Driver 4mm
 Ratchet 4.0mm



DE-1724
 Bone Universal Kit
 Drill: 2mm, 2.8mm, 3.2mm, 3.65mm,
 4.2mm, 4.5mm, 4.8mm, 5.2mm
 Trephines Bit:
 3.0mm, 4.0mm, 5.0mm, 6.0mm,
 7.0mm, 8.0mm, 9.0mm, 10mm.

Bone Compression:
 2mm, 3.3mm, 2.8mm, 4.2mm, 3mm, 3.5mm
 Driver:
 2.5mm, 2.5mm Hand Pcs
 1.25mm, 1.25mm Hand Pcs
 Short Driver 2.5mm
 Long Driver 2.5mm
 1.25mm, Short Hex Driver Hand Pcs
 1.25mm, Long Hex Driver Hand Pcs
 Torque Wrench 6.35mm 1 Pcs



DE-1725
 Conical Drills: 20 Pcs
 Tissue Punches:
 3.0mm, 3.50mm, 4.0mm, 4.5mm,
 5.0mm, 6.0mm, 6.50mm
 Bone Expander:
 1.6/3.8mm, 1.9/3.0mm, 2.1/3.6mm,
 2.6/3.8mm, 2.9/4.3mm
 Drill Adapter: 1 Pcs
 1.25mm, 2.50mm Hex Driver Hand Pcs

Pilot Drill: 1.6mm
 Drill Bit: 1.4mm, 1.6mm, 1.8mm, 2.0mm, 2.2mm
 Ratchet Driver: 4mm/6.35, 1.25/2.50
 Rimer: 3.2/4.7mm, 3.7/4.7mm
 Parallel Pin: 4.5mm, 2.5mm
 Double step Drill: 2.4/2.8mm
 Depth Gauge: 1 Pcs
 Torque Wrench 6.35mm Universal: 1 Pcs



- Инструменты для имплантологии
- Implantologie
- Implants
- Implants
- زراعة الأسنان

BONE INJECTORS, COLLECTORS & SUCTION TUBE



DE-1726
Ø 2,5mm / 3,5mm
170mm

DE-1727
Ø 4,5mm / 5,5mm
170mm

DE-1728
Ø 3,5mm / 4,5mm
170mm

DE-1729
Ø 6,0mm / 7,0mm
170mm

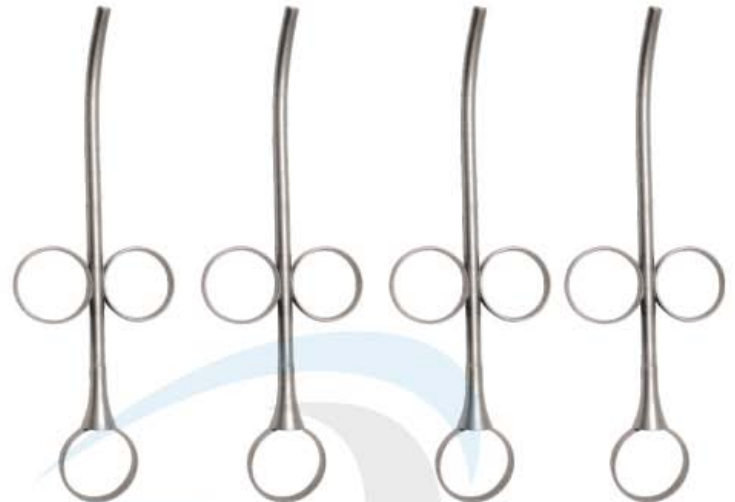

DE-1730
18cm
Straight / Bend
I.D 2.5mm
O.D 3.5

DE-1731
18cm
Straight / Bend
I.D 3.5mm
O.D 4.5

DE-1732
18cm
Straight / Bend
I.D 4.5mm
O.D 5.5

DE-1733
18cm
Straight / Bend
I.D 6.0mm
O.D 7.0



DE-1734
17.5cm

DE-1735
18cm

DE-1736
coarse
Ø 5mm

DE-1737
fine
Ø 9mm

Suction tubes to collect the extracted bone material 180mm



DE-1738
Suction Tubes
180mm

DE-1739
Suction Tubes
180mm

DE-1740
Suction Tubes
180mm



DE-1742
Ø 3 mm
length 180mm

DE-1743
Ø 4 mm
length 180mm

DE-1744
Ø 5 mm
length 180mm

DE-1741
Fig. 6FR
Frazier
15 cm - Ø 2 mm

IMPRESSION TRAYS

- Оттисковые ложки
- Відбиткові ложки
- Porte-empreinte
- Cubetas para impresiones
- Abdrucklöffel
- صواني الانطباع

PERFORATED WITH RIM LOCK

Set of 06 Pcs

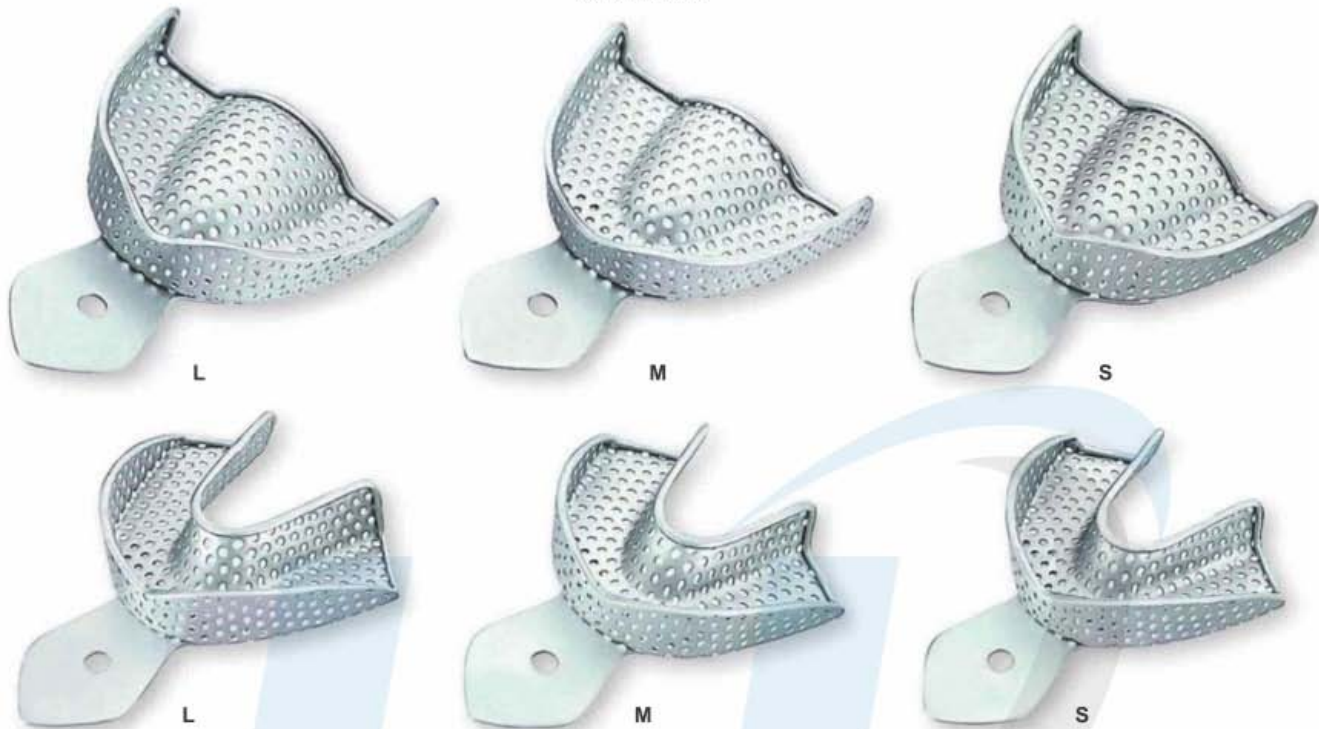

DE-1745 SET OF 06 PCS

Upper: S, M, L
Lower: S, M, L

PERFORATED WITH RIM LOCK

Set of 8 Pcs

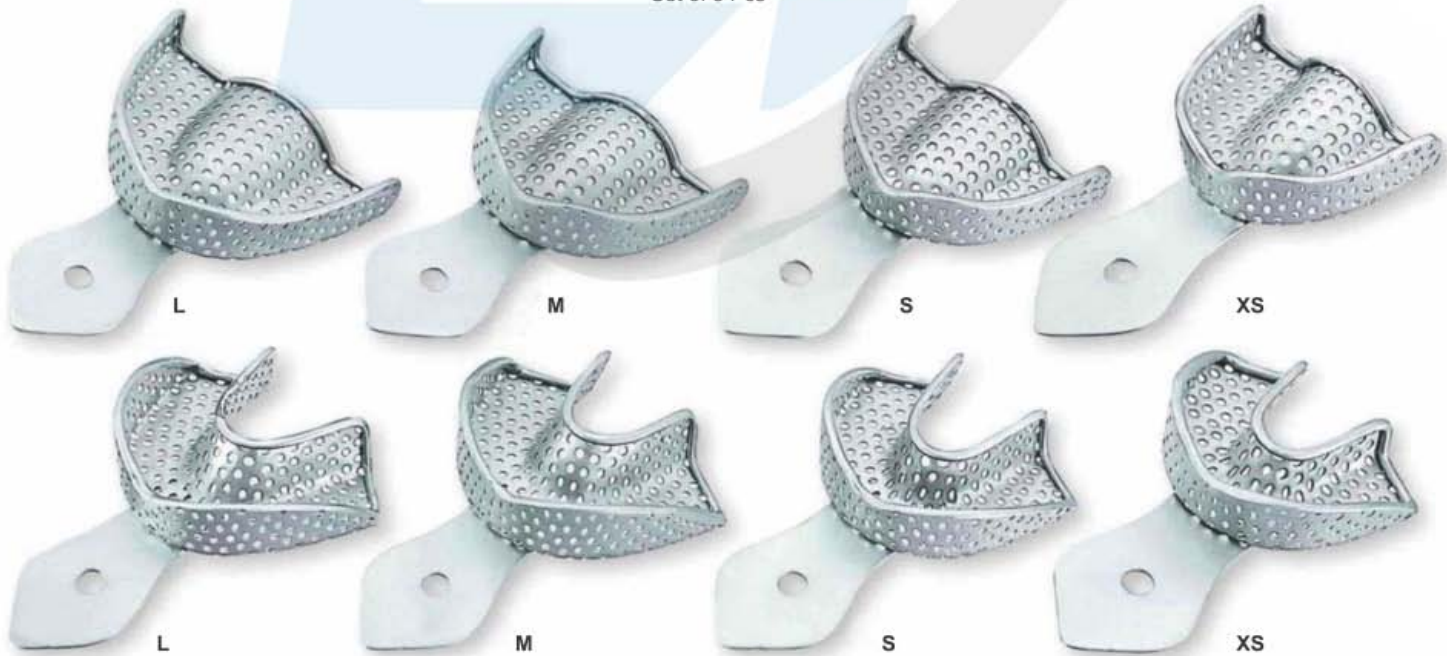

DE-1746 SET OF 08 PCS

Upper: XS, S, M, L
Lower: XS, S, M, L

DE-1747 SET OF 08 PCS

Upper: S, M, L, XL
Lower: S, M, L, XL

DE-1748 SET OF 10 PCS

Upper: XS, S, M, L, XL
Lower: XS, S, M, L, XL



- Оттисные ложки
- Porte-empreinte
- Abdrucklöffel

- Відбиткові ложки
- Cubetas para impresiones
- صواني الانطباع

SOLID WITH RIM LOCK
Set of 6 Pcs



DE-1749 SET OF 06 PCS
Upper: S, M, L
Lower: S, M, L

SOLID WITH RIM LOCK
Set of 8 Pcs



DE-1750 SET OF 08 PCS
Upper: XS, S, M, L
Lower: XS, S, M, L

DE-1751 SET OF 08 PCS
Upper: S, M, L, XL
Lower: S, M, L, XL

DE-1752 SET OF 10 PCS
Upper: XS, S, M, L, XL
Lower: XS, S, M, L, XL



IMPRESSION TRAYS

- Оттисковые ложки
- Porte-empreinte
- Abdrucklöffel
- Відбиткові ложки
- Cubetas para impresiones
- صواني الانطباع

PERFORATED FULL DENTURE Set of 8 Pcs

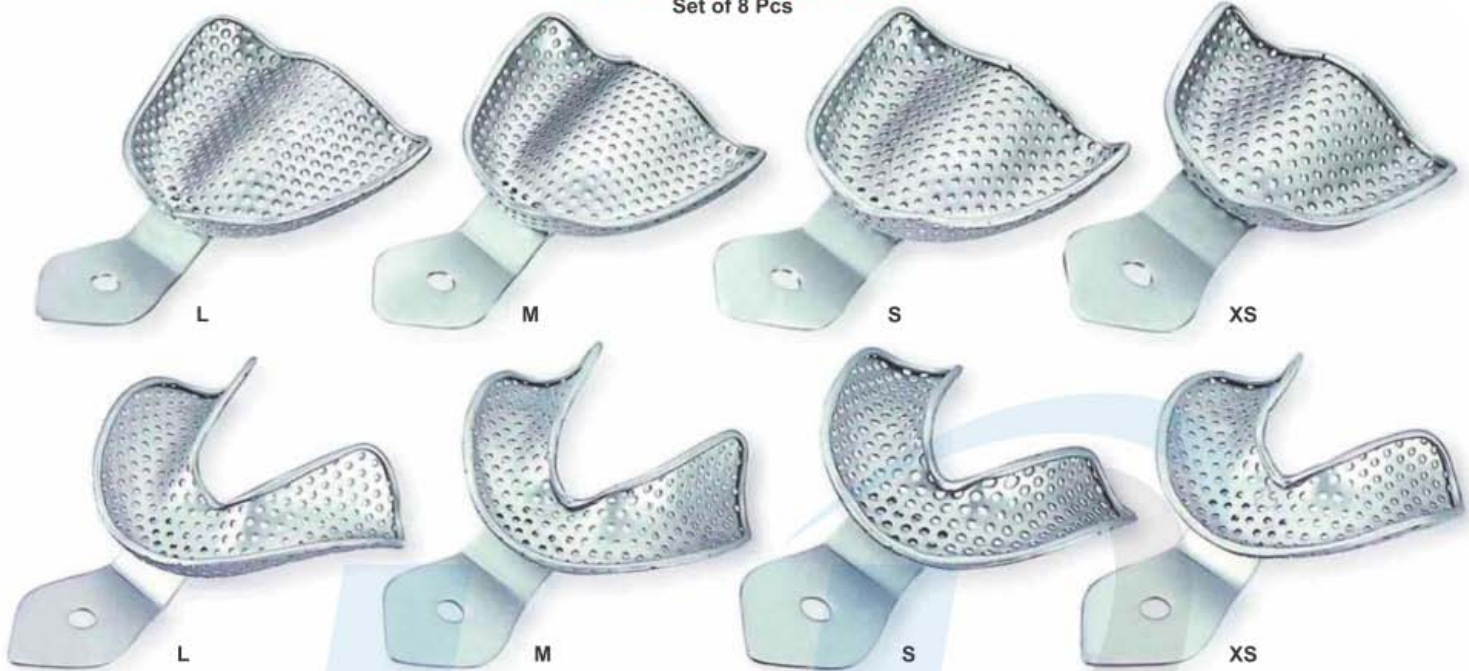

DE-1753 SET OF 08 PCS
Upper: S, M, L, XL
Lower: S, M, L, XL

DE-1754 SET OF 08 PCS
Upper: S, M, L
Lower: S, M, L

SOLID FULL DENTURE Set of 8 Pcs



DE-1755 SET OF 08 PCS
Upper: S, M, L, XL
Lower: S, M, L, XL

DE-1756 SET OF 06 PCS
Upper: S, M, L
Lower: S, M, L





IMPRESSION TRAYS

- Оттисные ложки
- Porte-empreinte
- Abdrucklöffel

- Відбиткові ложки
- Cubetas para impresiones
- صواني الانطباع

Perforated Without Rim Lock

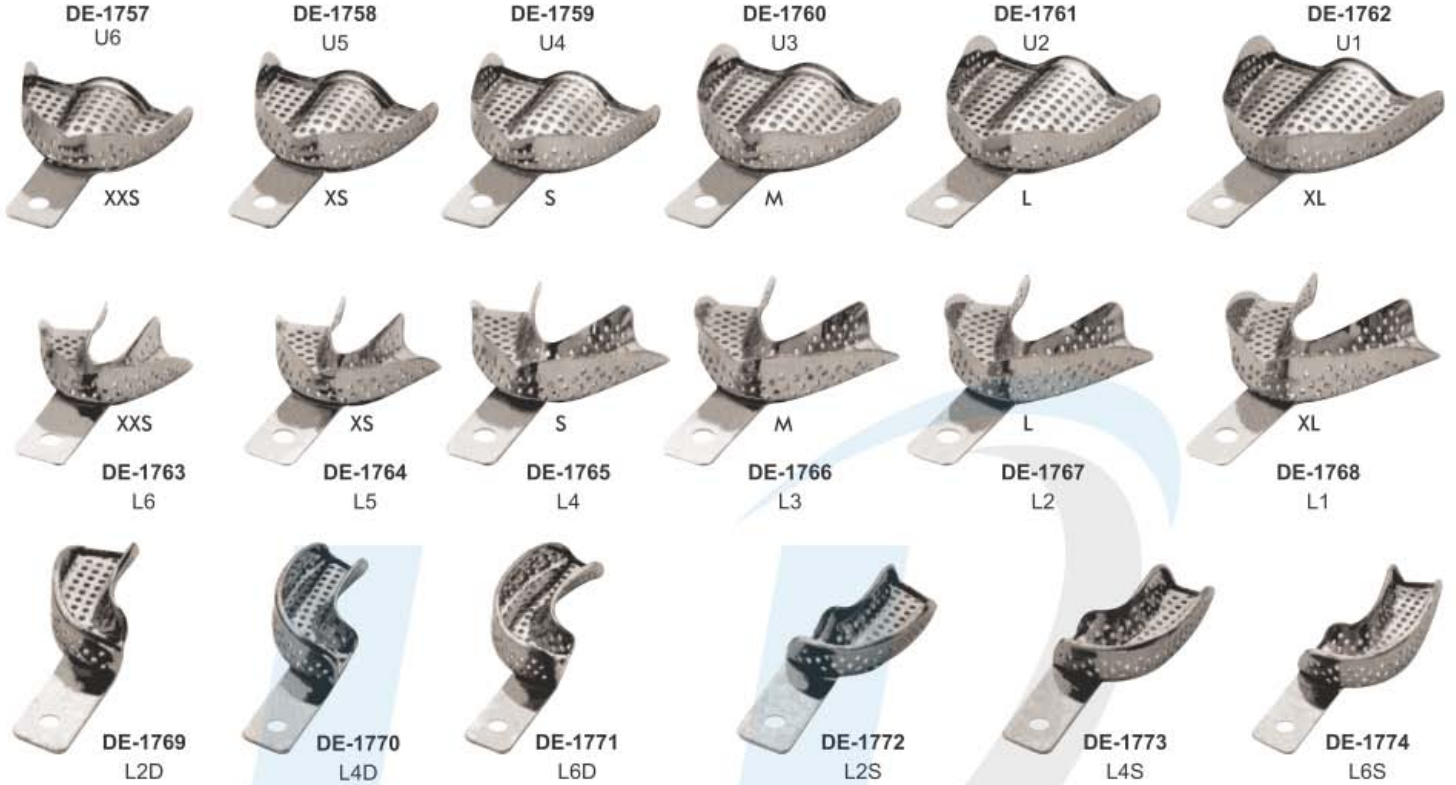

Solid With Rim Lock

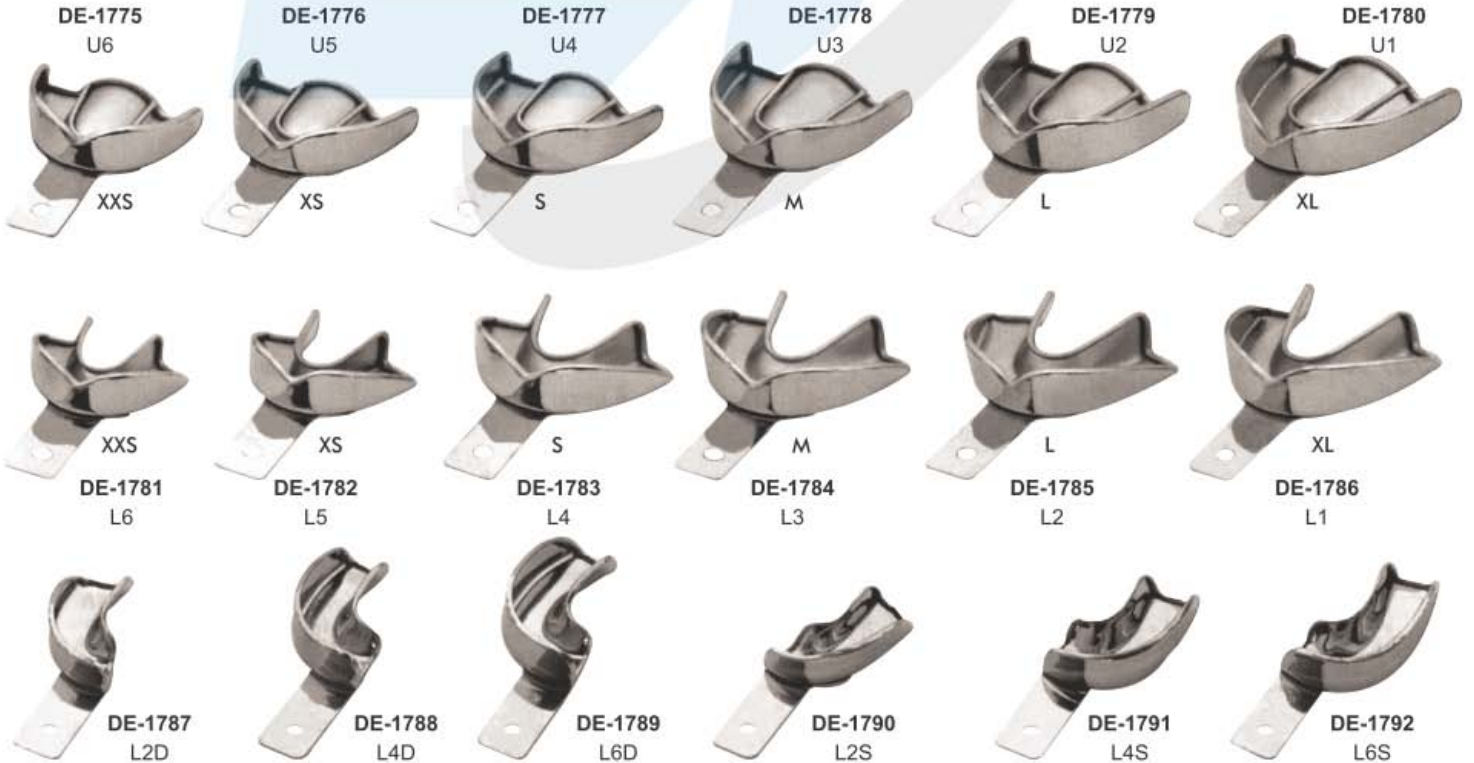



DE-1793
Mesh Cassettes
5 Pieces, 7 Pieces, 10 Pieces,
15 Pieces & 20 Pieces

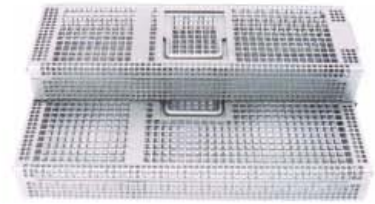

DE-1795
Instruments Cassette
7 Pieces & 10 Pieces



DE-1796
Gracey Curette Set Cassettes



DE-1797
182 x 150 x 20 mm
10 Instruments



DE-1798
180 x 85 x 15 mm
5 Instruments



DE-1799
288 x 182 x 35 mm
20 Instruments



DE-1800
288 x 182 x 35 mm
20 Instruments



DE-1801
182 x 145 x 35 mm
10 Instruments



DE-1802
182 x 72 x 35 mm
5 Instruments



DE-1803
182 x 145 x 35 mm
9 Instruments

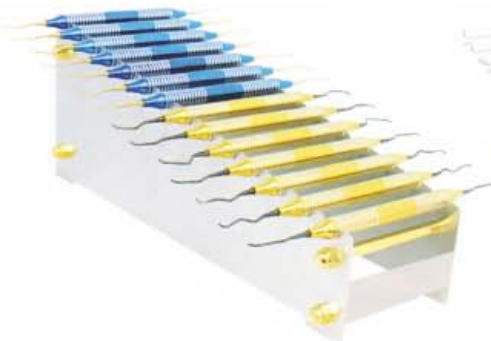

DE-1804
Gracey Curette Set Stand



DE-1805
Sinus Lift Set Stand





Made of 18/8 stainless steel



KIDNEY TRAY WITH COVER
(English Pattern)

DE-1806	Size
DE-1807	150 mm
DE-1808	200 mm
DE-1809	240 mm
	300 mm



Kidney Trays

With lid available		Without lid available	
DE-1810	6"	DE-1814	6"
DE-1811	8"	DE-1815	8"
DE-1812	10"	DE-1816	10"
DE-1813	12"	DE-1817	12"



Deep	DE-1818	2.25" - 2"
	DE-1819	4.75" - 2"
	DE-1820	5.5" - 2.5"
	DE-1821	6.25" - 2.75"
	DE-1822	7" - 3.5"



Sterilizing Drum

Art #	Ø mm	h mm
DE-1823	80	80
DE-1824	120	120
DE-1825	160	120
DE-1826	190	140
DE-1827	190	200
DE-1828	240	120
DE-1829	240	160
DE-1830	240	240
DE-1831	290	120
DE-1832	290	160
DE-1833	290	240
DE-1834	340	160
DE-1835	340	240
DE-1836	390	145
DE-1837	390	200
DE-1838	390	290



Bowl
DE-1839 Fig. 1 to 14



DE-1840
Endodontic Box



DE-1841 6" x 8"
DE-1842 8" x 10"
DE-1843 10" x 12"
Without Lid



DE-1844
Instruments Box



SCALER TRAY
DE-1845
100 x 200 mm

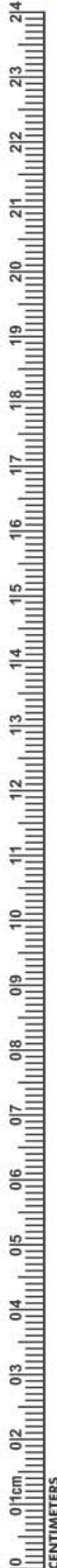

Sterilizing Cases Stainless Steel



- DE-1846 130X50X50 mm
- DE-1847 130X60X50 mm
- DE-1848 140X80X50 mm
- DE-1849 150X60X50 mm
- DE-1850 160X30X25 mm
- DE-1851 170X70X30 mm
- DE-1852 180X80X40 mm
- DE-1853 180X90X40 mm
- DE-1854 200X100X40 mm

- DE-1855 220X120X50 mm
- DE-1856 230X130X50 mm
- DE-1857 230X150X50 mm
- DE-1858 250X100X50 mm
- DE-1859 300X150X50 mm
- DE-1860 300X200X50 mm
- DE-1861 350X160X60 mm
- DE-1862 400X200X90 mm
- DE-1863 500X200X125 mm

- DE-1864 130X50X50 mm
- DE-1865 130X60X50 mm
- DE-1866 140X80X50 mm
- DE-1867 150X60X50 mm
- DE-1868 160X30X25 mm
- DE-1869 170X70X30 mm
- DE-1870 180X80X40 mm
- DE-1871 180X90X40 mm
- DE-1872 200X100X40 mm

- DE-1873 220X120X50 mm
- DE-1874 230X130X50 mm
- DE-1875 230X150X50 mm
- DE-1876 250X100X50 mm
- DE-1877 300X150X50 mm
- DE-1878 300X200X50 mm
- DE-1879 350X160X60 mm
- DE-1880 400X200X90 mm
- DE-1881 500X200X125 mm



INSTRUMENTS BOX

- DE-1882 130/50/50 mm
- DE-1883 130/60/50 mm
- DE-1884 140/80/50 mm
- DE-1885 150/60/50 mm
- DE-1886 160/30/25 mm
- DE-1887 170/70/30 mm
- DE-1888 180/80/40 mm
- DE-1889 180/90/40 mm
- DE-1890 200/100/40 mm
- DE-1891 220/120/50 mm

- DE-1892 230/130/50 mm
- DE-1893 230/150/50 mm
- DE-1894 250/150/50 mm
- DE-1895 300/150/50 mm
- DE-1896 300/200/50 mm
- DE-1897 350/160/60 mm
- DE-1898 350/160/60 mm
- DE-1899 400/200/90 mm
- DE-1900 500/200/125 mm



NEEDLES BOX

- DE-1901 150/60/20 mm
- DE-1902 140/80/20 mm
- DE-1903 220/120/20 mm



- FORCEPS JAR**
DE-1904 Fig. 1 to 5
- | Ø | h |
|----|-----|
| mm | mm |
| 52 | 100 |
| 52 | 130 |
| 52 | 175 |
| 70 | 130 |
| | 175 |
| | 200 |
| | 200 |



- Forceps Jars**
DE-1905 Fig. 3/3
- | Ø | h |
|----|-----|
| mm | mm |
| 25 | 130 |



- Forceps Jar**
- DE-1906 25 x 80mm
 - DE-1907 30 x 100mm
 - DE-1908 100 x 200mm
 - DE-1909 75 x 173mm





Cotton Holders
DE-1910 Fig. 000/1
Mm 55 Hmm 70



Cotton Holder -
DE-1911



DE-1912
Sprit Lamp
Single Nut



DE-1913
Sprit Lamp

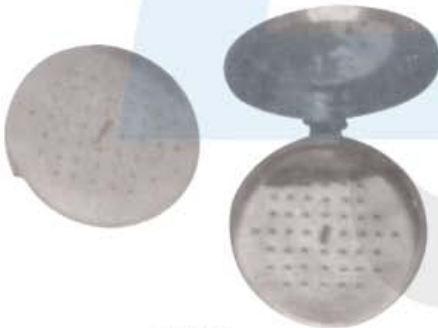

DE-1914
Endodontic Box
Small & Large



DE-1915
Needle Case Round with Cover



DE-1916
Bedpan Perfection Type
Small & Large



DE-1917
Urinal Female, Urinal Male, Urinal Male Vertical

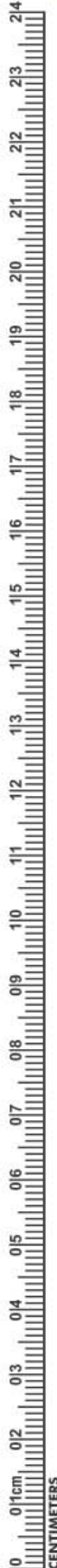

IMPLANTOLOGY



- Инструменты для имплантологии
- Implantologie
- Implantologie
- Инструменти для імплантології
- Implantologia
- زراعة الأسنان



DE-1918
Endo Finger Ruler
Span Measure Scale



DE-1919
Endo Finger Ruler
Span Measure Scale



DE-1920
Endo Finger Ruler
Span Measure Scale



DE-1921
Amalgam Gun



DE-1922
Brush Stainless Steel



DE-1923
Suction Cannula Kit
with 3 Needles



DE-1924
Suction Pipe



DE-1925
Suction Needle
1mm



DE-1926
Suction Needle
1.5mm



DE-1927
Suction Needle
2mm





DESCRIPTION	PAGE #	DESCRIPTION	PAGE #	DESCRIPTION	PAGE #
3 PRONG CLASP ADJUSTABLE PLIER TC	107	BEDPAN PERFECTION TYPE SMALL & LARGE	150	EXPLORERS INSTRUMENTS	35
ACORN FILLING INSTRUMENTS	52	BRUSH STAINLESS STEEL	151	EXPLORERS	33-45
ADAM PLIER WITH TC	102	COMPOSITE FILLING INSTRUMENTS	74A	EXTRACTING FORCEPS (AMERICAN PATTERN)	10-14
ADAMS PLIER ROUND BOX	100	COMPOSITE FILLING INSTRUMENTS	74B	EXTRACTING FORCEPS (ENGLISH PATTERN)	01-02, 05-07
ADAMS PLIERS FOR BENDING WIRE	100	COMPOSITE FILLING INSTRUMENTS	74C	EXTRA-FLEX IMPLANTOLOGY INSTRUMENTS	114
ADAMS, SMALL WIRE BENDING AND LOOP FORMING PLIERS	99	COMPOSITE FILLING INSTRUMENTS	74C	ENDODONTIC BOX SMALL & LARGE	150
ADERER FACEBOW LOOP FORMING PLIERS	101	COMPASSO DE WILLIS	96	ENDO FINGER RULER SPAN MEASURE SCALE	96
ADERER LARGE WIRE BENDING AND LOOP FORMING PLIERS	100	COTTON HOLDERS	150	ENDO FINGER RULER SPAN MEASURE SCALE	151
ADERER PLIER	101	CARRY FORCEPS	134	FORCEPS JAR	149
AMALGAM GUN	151	CARVER HOLLENBACK AMALGAM CARVERS	56	FALCON BEAK CONTOURING PLIERS	100
ARROW CLASP FORMING PLIERS	106	CARVERS FILLING INSTRUMENTS	69	FARABEU RETRACTOR	82
ADSON BROWN TWEEZERS	32	CARVERS INSTRUMENTS	73	FELDMAN RETRACTOR	82
ADSON CARBIDE TIPPED TISSUE FORCEPS	133	CARVERS	71	FILES FILLING INSTRUMENTS	53
ADSON NEEDLE HOLDERS	86	CASTROVIEJO NEEDLE HOLDERS	86	FILLING INS PERIODONTAL INSTRUMENTS	39
ADSON TWEEZERS	32	CASTROVIEJO SCISSORS	84	FILLING INSTRUMENTS	37, 44, 49-55, 69, 72
ADSON-TC TWEEZERS	32	CEMENT SPATULAS	75	FLAT NOSE PLIER SMOOTH	105
ALLEN PERIOSTEAL ELEVATORS	95	CHEEK RETRACTOR LONG	80	FLAT NOSE PLIER WITH SERRATION	105
ALLIS 4.5 HAEMOSTATIC FORCEPS	87	CHEEK RETRACTOR	78	FLOHR ROOT ELEVATORS	20
ALLIS-BABY 3/4 HAEMOSTATIC FORCEPS	87	CHEEK RETRACTORS, MINNESOTA	80	FLUCH-CUT DISTAL AND CUTTING PLIERS	100
AMALGAM CARVERS	56-57, 70-71	CHEEK RETRACTORS, RETRACTOR IVORY	80	FOERSTER DRESSING FORCEPS	100
AMALGAM FILES	71	CHEEK RETRACTORS, TONGUE DEPRESSORS	80	FORCEP JAR	148
AMALGAM INSTRUMENTS & SCALPEL HANDLES	92	CHISELS HOES FILLING INSTRUMENTS	74	FREEDMAN "DUCKHEAD" IMPLANTOLOGY INSTRUMENTS	112
AMALGAM INSTRUMENTS	93	CLAMP OSTEOMETER	109	FREEDMAN BURNISHERS IMPLANTOLOGY INSTRUMENTS	112
AMALGAM WELL MATRIX RETAINERS	93	CLAPPISON/FRAHAM RESTORATIVE INSTRUMENTS	70	FREER PERIOSTEAL ELEVATORS	95
AMALGAM WELL	93	CLAW-LIFT ROOTS ELEVATOR	22	FRIEDMAN BONE ROUNGER	14
ANATOMICAL CARVER	71	COHEN UNIVERSAL FORCEPS	10-11	FRIEDMANN ROOTS ELEVATOR	21
ANDREW RESTORATIVE INSTRUMENTS	70	COLLEGE CURVED	32	GAUGE FOR MEASURING	109
ANGLE FORMERS	72	COLLEGE TWEezer	32	GERALD TWEEZERS	31
ANGLED DIRECT BOND BRACKET REMOVER TC	106	COLLEGE WITH LOCK TWEEZERS	31	GILLES TWEEZERS	31
ANISWORTH CLAMPS FORCEPS	88	COLLINS TONGUE FORCEPS	31	GILLIES NEEDLE HOLDER WITH SCISSORS	31
ANTERIOR FILLING INSTRUMENTS	68	COMPOSITE/PLASTIC FILLING INSTRUMENTS	49-50, 54	GOLDMAN FOX EXPLORERS	36
ANTERIOR	47	CONDENSER INSTRUMENTS	118	GOLDMAN FOX MERRIT B EXPLORERS	36
APEX ROOT ELEVATORS	15-19	CONDENSER MORTONSON FILLING INSTRUMENTS	50	GOLDMAN FOX UNIVERSITY OF MICHIGAN EXPLORERS	36
APICAL ROOT ELEVATORS	19	CONTOURING INSTRUMENT IMPLANTOLOGY INSTRUMENTS	111	GOLDMAN FOX WILLIAMS EXPLORERS	36
ARCH FORMING PLIERS	104	CONTOURING PLIER	101	GOLDMAN PERIODONTAL INSTRUMENTS	58
ARTICULATORS	77	COSMETIC CONTOURING	113	GOLDMAN-FOX PERIOSTEAL ELEVATORS	95
A-TRAUMATIC EXTRACTION SET	03	COTTON HOLDER	148	GOLDMAN-FOX SCISSORS	83-84
ATRAUMATIC TWEEZERS	31	COUPLAND ROOT ELEVATORS	17	GOLDMAN-FOX SET	61
BACK ACTION FILLING INSTRUMENTS	52	COUPLAND ROOT ELEVATORS	18	GOLDSTEIN INTERPROXIMAL EXCAVATOR	87
BACKHAUS HAEMOSTATIC FORCEPS	87	CRANE KAPLAN TWEEZERS	32	GRACEY AFTER FIVE	62
BACOLITE HANDLE WAX KNIVES	76	CRANE-KAPLAN PERIODONTAL INSTRUMENTS	59	GRACEY CURETTE INSTRUMENTS	42
BALDWIN FILLING INSTRUMENTS	49	CRILE NEEDLE HOLDERS	85	GRACEY CURETTE SET CASSETTES	147
BALL FILLING INSTRUMENTS	52	CRILE-WOOD NEEDLE HOLDERS	85-86	GRACEY CURETTE	43
BALL HOOK CRIMPING PLIER	105	CROWN AND BAND CONTOURING PLIERS	90	GRACEY MINI FIVE	42
BAND PUSHER	90	CROWN REMOVER	90	GRACEY PERIODONTAL INSTRUMENTS	39
BAND REMOVING PLIER	99	CROWN SPREADERS	90	GRACEY SET OF 7 PCS	40-41
BAND SEATER AUTO CLEAVABLE	97	CRAYER EXTRACTING FORCEPS	10	GRAFT PACKER, CONCAVE TIPS	125
BAND SEATING PLIER	104	CRAYER ROOTS ELEVATOR	23	GREGG IMPLANTOLOGY INSTRUMENTS	111
BANDS & CROWNS PLIER	101	CURETTE COLUMBIA	43	GRITMAN CEMENT SPATULAS	75
BASINS FOR BONE	138	CURETTE INSTRUMENTS	63	GROSS MAIER DRESSING FORCEPS	100
BAUMGARTNER NEEDLE HOLDERS	85	CURETTE MCCALL	43	GUM SCISSORS	100
BAUMGARTNER NEEDLE HOLDERS	86	CURETTE	60	HAEMOSTATIC FORCEPS & TOWEL CLAMPS	87
BAYONET ROOTS ELEVATOR SET	81	CURETTES SET OF 8 PIECES	43	HALSEY NEEDLE HOLDERS	85-86
BEAVERTAIL FILLING INSTRUMENTS	52	CURETTES	40-43, 61-62	HALSTEAD MOSQUITO HAEMOSTATIC FORCEPS	87
BEEBEE NEEDLE HOLDERS	85	CUTTING INS PERIODONTAL INSTRUMENTS	39	HALSTEAD MOSQUITO NEEDLE HOLDERS	86
BEIN ROOT ELEVATORS	15-16, 24	DARBY-PERRY EXCAVATORS	65	HALTEPINZETTE WITH LOCK	134
BEYER BONE ROUNGER	14	DE LA ROSA PLIERS WITH GROOVED	105	HAMMER HEAD TIE BACK PLIER	104
BINANGLE FILLING INSTRUMENTS	74	DE LA ROSA PLIERS	105	HANDLES FOR MOUTH MIRRORS	30
BIRD BEAK ANGLED BENDING PLIER	103	DEAN SCISSORS	84	HARD WIRE CUTTERS	107
BIRD BEAK PLIER WITH TC	102	DEBAKEY ATRAUMATIC TISSUE FORCEPS	133	HARRIS EXTRACTING FORCEPS	86
BIRD BEAK WIRE BENDING & CUTTING PLIERS	101	DEEP BOWL	148	HARTMANN (BABY MOSQUITO) NEEDLE HOLDERS	11
BIRD BEAK WIRE BENDING PLIER	100	DEEP ROOT PICK FORCEPS (APICAL SET OF 9)	04	HATCHETS FILLING INSTRUMENTS	68
BIRD BEAK WITH CUTTER PLIERS	104	DELICATE NEEDLE HOLDERS	85	HEAT CARRIERS	46
BLACK FILLING INSTRUMENTS	50	DELUXE BRACKET HOLDER TWEEZERS	96	HEBER ROOTS ELEVATOR	24
BLACK TITANIUM COLOUR COATED INSTRUMENTS	110-111	DENHARD CHEEK RETRACTORS	79	HEIDBRINK ROOT ELEVATORS	20-21, 26
BLADE AND PUSHER	126	DENTAL MIRROR PERIODONTAL INSTRUMENTS	39	HEIDMANN PERIODONTAL INSTRUMENTS	39
BLUMENTHAL BONE ROUNGER	14	DENTAL SYRINGES	13	HEMINGWAY CURETTE INSTRUMENTS	63
BOGHOSIAN FILLING INSTRUMENTS	49	DERF NEEDLE HOLDERS	85	HEMINGWAY TWEEZERS	32
BOGHOSIAN IMPLANTOLOGY INSTRUMENTS	111	DERF NEEDLE HOLDERS	86	HOES	71
BOLEY GAUGE	109	DIRECT BOND BRACKET HOLDER TWEEZERS	96	HOLLANBACK PERIODONTAL INSTRUMENTS	39
BONE BRACKET GAUGE	96	DIRECT BONDING BRACKET HOLDERS	96	HOLLANBACK FILLING INSTRUMENTS	50
BONE CARRIER TITANIUM	124	DIRECT BONDING BRACKET REMOVER PLIER TC	106	HOLLANBACK IMPLANTOLOGY INSTRUMENTS	114
BONE CRUSHER	138, 140	DIRECT BRACKET REMOVER TC	107	HOLLANBACK RESTORATIVE INSTRUMENTS	70
BONE EXPANDER SCREW & SURGICAL KITS	141	DISCOID-CLEOD CARVER	71	HOLLOW HANDLE	132
BONE FILES	94	DISTAL END CUTTER REGULAR WITH TC	102	HOLLOW WARE	148
BONE GRAFT/CARRIER TITANIUM	128	DISTAL END CUTTER, SAFETY HOLD PLIER	102	HOLLOWCHOP CONTOURING PLIERS	106
BONE GRAFTING INSTRUMENTS COMPACTOR /TAMPERS	125	(IDEAL FOR CUTTING WIRE) TC	107	HOOK CRIMPING PLIER ANGLED STRAIGHT TC	107
BONE GRAFTING INSTRUMENTS	126-127	DISTAL END, WIRE CUTTERS & BRACKET REMOVER PLIERS	107	HOOK KNIVES	76
BONE INJECTORS, COLLECTORS & SUCTION TUBE	142	DOUBLE ENDED CEMENT SPATULA	98	HOW PLIER CURVED WITH TC	103
BONE MILL	138	DISTAL CUTTER	106	HOW PLIER CURVED	99, 104
BONE ROUNGER	14	DRESSING TWEEZERS	31-32	HOW PLIER STRAIGHT WITH TC	103
BONE SCRAPER STRAIGHT & CURVED	138	DENTAL SYRINGES ALL TYPES	14H	HOW PLIER STRAIGHT	103
BONE SPOON/ PACKER	125	ELASTIC SEPARATING PLIER	107	HOWARD PERIOSTEAL ELEVATORS	95
BONE THICKNESS GAUGE	109	ELASTOMERIC LIGATURE PLACING FORCEPS	107	HYGIENIST PERIODONTAL INSTRUMENTS	58
BONE UNIVERSAL KIT	141	WITH GROOVE FALCON	107	HYGIENIST-JACQUETTE PERIODONTAL INSTRUMENTS	58
BRACKET REMOVER ANGULATED PLIER	103	ELLIOT MATRIX RETAINERS	91	HYGIENIST-TOWNER PERIODONTAL INSTRUMENTS	58
BRACKET REMOVER PLIER STRAIGHT	103	ENDED CHEEK RETRACTORS	79	HYLIN CEMENT SPATULAS	75
BRACKET REMOVER PLIERS ANGLED WITH TC	102	ENDODONTIC BOX	148	HYLIN ROOTS ELEVATOR	23
BRACKET REMOVER PLIERS STRAIGHT WITH TC	102	ENDODONTICS INSTRUMENTS	47	HEIGHT GAUGE MOVABLE	96
BRACKET REMOVING PLIER ROUND BOX	99	ENGLISH PATTERN KLEIN #3 PEDODONTIC UNIVERSAL FORCEPS	08	IMPLANT GAGES	108
BRACKET REMOVING PLIER	99	EXAMINATION KIT SET OF 3 PIECES	34	IMPLANT SINUS LIFT INSTRUMENTS	117, 122
BREWER CLAMPS FORCEPS	88	EXAMINATION SET OF 4 PIECES	34	IMPLANT	123
BURNISHER FILLING INSTRUMENTS	49	EXAVATORS	37	IMPLANTOLOGY IMPLANTOLOGY INSTRUMENTS	111
BURNISHER FILLING INSTRUMENTS	49	EXCAVATOR PERIODONTAL INSTRUMENTS	39	IMPLANTOLOGY INSTRUMENTS	112
BURNISHER UNIVERSITY OF MICHIGAN AMALGAM CARVERS	56	EXCAVATORS INSTRUMENTS SET OF 11 PIECES	57	IMPLANTOLOGY	108-110
BURNISHERS FILLING INSTRUMENTS	52-53	EXCAVATORS INSTRUMENTS	64-67	IMPRESSION TRAYS	143-146
BURNISHERS IMPLANTOLOGY INSTRUMENTS	112	EXCAVATORS	64	INSTRUMENTS BOX	148
BUSER PERIOSTEAL ELEVATORS	95	EXPLORER PERIODONTAL INSTRUMENTS	39	INSTRUMENTS CASSETTES & STANDS	147



DESCRIPTION	PAGE #	DESCRIPTION	PAGE #	DESCRIPTION	PAGE #
INSTRUMENTS BOX	149	NANCE LOOP FORMING PLIERS	99	ROUND NOSE PLIER	104
NEEDLES BOX	149	NANCE PLIER	105	ROUNDED CONE	73
INTERPROXIMAL CARVER IMPLANTOLOGY INSTRUMENTS	111	NARROW MATRIX RETAINERS	91	ROUNDED-CONE FILLING INSTRUMENTS	49
INTERPROXIMAL OFF-ANGLE FILLING INSTRUMENTS	49	NEEDLE HOLDERS	85-86	RUBBER DAM CLAMPS	89
INTRALIGAMENTAL ANESTHESIA SYRINGE	13	NEUMANN SCISSORS	84	RUBBER DAM CLAMPS FORCEPS	134
IRIS SCISSORS	83-84	NOYES SCISSORS	84	RUSSIAN LONG TISSUE FORCEPS	134
IVORY LIGHT WEIGHT CLAMPS FORCEPS	88	NEEDLE CASE ROUND WITH COVER	150	RUSSIAN TISSUE FORCEPS	134
IVORY MATRIX RETAINERS	91	OCCUSAL ANATOMY INSTRUMENT	113	SCALER TRAY	148
IWANSON SPRING CALIPER	109	OHL PERIOSTEAL ELEVATORS	95	SCALER/CURETTE SETS	60
JACQUETTE SCALERS PERIODONTAL INSTRUMENTS	59	OLSEN-HEGAR NEEDLE HOLDER WITH SCISSORS	95	SCALER/CURETTE SETS INSTRUMENTS	61
JARA BEAK PLIER	104	OREGON PLUGGERS/CONDENSERS	51	SCHURE BAND SEATER	97
JENNINGS CHEEK RETRACTORS	79	ORTHO BAND PUSHER SCALER	98	SEPARATING ELASTIC PLIER	88
JOHNSON CONTOURING PLIERS	100	ORTHO INSTRUMENT	97	SELDIN PERIOSTEAL ELEVATORS	95
JONES HAEMOSTATIC FORCEPS	87	ORTHO LIGATURE DIRECTOR SINGLE ENDED	98	SELDIN RETRACTOR	82
JOSEPH SCISSORS	84	ORTHO LIGHT BAND PUSHER SCALER	97-98	SELDIN ROOT ELEVATORS	15-18, 25
KELLY HAEMOSTATIC FORCEPS	87	ORTHO LIGHT DOUBLE ENDED LIGATURE DIRECTOR SCALER	98	SELF LOCKING GROOVED	133
KELLY SCISSORS	83-84	ORTHO LIGHT DOUBLE ENDED LIGATURE DIRECTOR	98	SELF-LOCKING TWEEZER	32
KELLY-RANKIN HAEMOSTATIC FORCEPS	87	ORTHO LIGHT DOUBLE ENDED LIGATURE SCALER	98	SEMKEN TAYLOR TWEEZERS	31
KEYS FOR IMPLANT SCREW	139	ORTHO LIGHT DOUBLE ENDED LIGATURE SCALER/DIRECTOR	98	SICKLE PERIODONTAL INSTRUMENTS	39
KIDNEY TRAY WITH COVER (ENGLISH PATTERN)	148	ORTHO LIGHT LIGATURE DIRECTOR DOUBLE ENDED	98	SICKLE SCALERS INSTRUMENTS	58
KIDNEY TRAYS	148	ORTHO LIGHT SCALER DOUBLE ENDED	97	SINGLE ENDED PROBE	33
KILNER (RAGNELL) SCISSORS	84	ORTHO LIGHT SCALER HEAVY	97	SINUS LIFT ELEVATOR	115-116
KLEINERT-KUTZ BONE ROUNDER	14	ORTHO LIGHT SCALER SINGLE ENDED	98	SINUS LIFT INSTRUMENT	118-121
KOPP ROOTS ELEVATOR	23-24	ORTHO LIGHT SCALER	97	SCHWARZ PLIER	106
KRARNER-NEVINS BONE CHISEL	94	ORTHODONTIC INSTRUMENTS	96-98	SINUS LIFT SET STAND	147
LA GRANGE SCISSORS	83-84	ORTHOLITE LIGATURE DIRECTOR SCALER	98	SINUS WINDOW BONE TAMPERS	127
LADMORE FILLING INSTRUMENTS	52	OSTEOMETER MEASURING FORCEPS	96	SINUSLIFT INSTRUMENTS	118
LADMORE IMPLANTOLOGY INSTRUMENTS	112	OSTEOTOME CONVEXES / CONCAVE / CONIQUES	135-136	SIOVELAND RETAINERS TOFFLEMIRE-JUNIER MATRIX RETAINERS	91
LAP-JOINT THREE PRONG PLIER	106	OVAL SPOONS/DARBY-PERRY	65	SMAHA ELASTOMERIC LIGATURE PLACING FORCEPS	107
LAXUTOR ROOT ELEVATORS	19	P.K. THOMAS WAXING INSTRUMENTS	73	SPENCER SCISSORS	84
LE CRON CEMENT SPATULAS	75	PALATAL ARCH PLIER	105	SPIRIT LAMP	148
LESSMANN	76	PALMER CLAMPS FORCEPZ	88	SPOON AND PUSHER (TRINOVO)	128
LIGATURE FORMING PLIERS	101	PDL ELEVATORS	28-29	SPOON AND PUSHER WITH SAFETY STOP	128
LIGHT WIRE BIRD BEAK LONG PLIER WITH TC	102	PEDIATRIC TOOTH EXTRACTING FORCEPS SET	09	SPOONS	64
LIGHT WIRE BIRD BEAK LONG PLIER	104	PERIODONTAL FILLING INSTRUMENTS	53	SPREADERS	46
LIGHT WIRE BIRD BEAK PLIERS	104	PERIODONTAL INSTRUMENTS	37, 39, 58, 60, 95	STANDARD LIGATURE CUTTER TC	106
LIGHT WIRE CUTTER MICRO WITH TC	102	PERIODONTAL PROBES	46, 48	STEP PLIERS WITH TC	103
LIGHT WIRE PLIER	104	PERIOSTEAL ELEVATOR	95, 129-130	STERILIZING DRUM	148
LINDO LEVIAN ROOT ELEVATORS	20	PERIOTOME ROOTS ELEVATOR	26	SPLIT LAMP SINGLE NUT	150
LINGUAL / PALATAL ARCH FORMING PLIERS	101	PERRY TWEEZER	31-32	SPIRIT LAMP	150
LINGUAL PLIER LONG HANDLE	106	PESTERIOR BEND REMOVER PLIER LONG	103	SUCTION CANNULA KIT	151
LINGUAL PLIER WEINGART	106	PESTERIOR BEND REMOVER PLIER MEDIUM	103	STERILIZING CASES STAINLESS STEEL	149
LINGUAL WEINGART PLIER	106	PESTERIOR BEND REMOVER PLIER SHORT	103	STOP V BENDING PLIER	105
LINING APPLICATOR DOUBLE END	55	PIN & LIGATURE CUTTERS TC	106	STRAIGHT DIRECT BOND BRACKET REMOVER TC	107
LOCKLIN SCISSORS	84	PIN HOLDING PLIER TC	107	SURGICAL CHISELS	123
LONDON COLLEGE TWEEZERS	31	PIN-TWEEZERS	134	SURGICAL TWEEZERS	31
LORNA HAEMOSTATIC FORCEPS	87	PLAIN MIRRORS	30	SUTURE PLIERS SUTURE FORCEPS	133
LUCAS	132	PLASTER KNIFE 76 SPECIAL INOX	76	SYNDESMOTOMES ROOTS ELEVATOR	26
LUER BONE ROUNDER	14	PLIERS FOR ORTHODONTICS & PROSTHETICS	99-106	TAMPER	126
LUKS	47	PLUGGER PERIODONTAL INSTRUMENTS	39	TANNER FILLING INSTRUMENTS	52, 69
LUXATOR ROOT ELEVATORS	15-16, 21	PLUGGER BLACK AMALGAM CARVERS	56	TANNER IMPLANTOLOGY INSTRUMENTS	114
LUXIER ROOTS ELEVATOR	22	PLUGGERS	45, 48	TC GRIPPER CARBIDE	133
MAGNIFYING MIRRORS	30	PLUGGERS/CONDENSERS FILLING INSTRUMENTS	50	THARP RESTORATIVE INSTRUMENTS	70
MANUAL CROWN REMOVER	90	PLUGGERS/CONDENSERS	51	THREE PRONG PLIERS REGULAR	106
MARCOTTE LOOPING PLIER	105	POINTED CURETTE	60	TISSUE GRAFT FORCEP SERRATED TEETH	133
MARGIN TRIMMERS	72	POINTED PROBES SINGLE ENDED	36	TISSUE MEMBRANE FORCEPS	132, 134
MARGINAL RIDGE & EMBRASURE SHAPING INSTRUMENT	113	POSTERIOR	48	TISSUE PUNCH FORCEPS	134
MARKLEY PLUGGERS/CONDENSERS	51	POSTERIOR BAND REMOVER PLIERS	102	TISSUE PUNCH STRAIGHT & CURVED	138
MARQUETTE FILLING INSTRUMENTS	50	POTT ROOTS ELEVATOR	25	TOFFLEMIRE-SENIOR MATRIX RETAINERS	91
MARYAM TWEEZERS	32	POWER CROWN REMOVER LIFT	90	TOFFLEMIRE-UNIVERSAL MATRIX RETAINERS	91
MATHIEU NEEDLE HOLDERS	86	PRICHARD PERIOSTEAL ELEVATORS	95	TORQUE WRENCH & RATCHET	139
MATRIX RETAINERS	91	PROBES DOUBLE ENDED	35	TOWNER PERIODONTAL INSTRUMENTS	58
MAYO NEEDLE HOLDERS	85	PROBES SINGLE ENDED	34	TOWNER-JACQUETTE PERIODONTAL INSTRUMENTS	58
MAYO SCISSORS	83	QUETIN FILLING INSTRUMENTS	49	TREPHINE DRILL SET OF EIGHT PIECES	137
MAYO-HEGAR NEEDLE HOLDERS	85-86	RASPATOR, BENOUE	131	TUFTS FILLING INSTRUMENTS	49
MEAD 1A BONE ROUNDER	14	RASPATOR, FREER	129, 131	TUNNELIERUNGS INSTRUMENT	126
MEAD BONE FILES	94	RASPATOR, MICRO FREER	131	TWEED / ANGLE FORMING AND TORQUING PLIERS	101
MEASURING LOOP	109	RASPATOR, MICRO RASPATOR / CHISEL	131	TWEED / ANGLE RECTANGULAR ARCH FORMING & TORQUING PLIERS	100
MEASURING LOOP, CASTROVIEJO	109	RASPATOR, MICRO-FREER	129	TWEED ARCH FORMING PLIER TC	102
MEDIUM CEMENT CEMENT SPATULAS	75	RASPATOR, NORDBERG	131	TWEED CUTTER PLIER	104
MEDIUM PLACING/CONDENSING IMPLANTOLOGY INSTRUMENTS	114	RASPATOR, PRICHARD	124	TWEED LOOP FORMIN PLIERS	100
MEMBRANE POSITIONING INSTRUMENTS	118	RASPATOR, RASPARTY PERIOSTEAL ELEVATORS	95	TWEED LOOP FORMING PLIER TC	105
MEMBRANE TWEEZERS KUEHNE	134	RASPATOR, WAUTIER	131	TWEED LOOP FORMING PLIERS	99
MERIAM TWEEZERS	31	RASPATOR, WILLIGER PERIOSTEAL ELEVATORS	95	TWEED LOOP PLIER	104-105
MERRIT A EXPLORERS	36	RUBBER DAM FRAME	88	TWEezer PERIODONTAL INSTRUMENTS	39
MERRIT B EXPLORERS	36	RASPATORY CHIPPING	131	TWEEZERS	31
MERSHON CROWN REMOVER	90	RASPATORY MICRO MOLT	131	TWEEZERS	32
METZENBAUM NEEDLE HOLDERS	85	RASPATORY MOLT	131	TWIEL-ON ELASTIC MODULE INSTRUMENT	97
METZENBAUM SCISSORS	83	REGULAR TWEED ARCH FORMING PLIERS	104	UNIVERSAL DOLPHIN STYLE WIRE BENDING & CUTTING PLIERS	99
MICOR ADSON TISSUE FORCEP	133	RESTORATIVE INSTRUMENTS	51-53, 68, 70-72	UNIVERSAL FILLING INSTRUMENTS	49
MICRO IRIS SCISSORS	83	RETRACTOR WITH ERGO GRIP	90	UNIVERSAL FILLING INSTRUMENTS	54
MICRO-FRIEDMAN BONE ROUNDER	14	RETRACTORS - MOUTH GAGS	78-79	UNIVERSAL NEEDLE HOLDERS	85
MILLER BONE FILES	94	RETRACTORS	80-82	UNIVERSITY OF MICHIGAN EXPLORERS	36
MILLER TWEEZERS	32	RETRACTORS CHEEK RETRACTOR COMBINATION COMBINATION	80	UTILITY PLIER WEINGART TC	107
MILLER	132	RETRACTORS COMBINATION	81	V BEND STOP PLIER TC	106
MINI LIGATURE CUTTERS	100	RETRACTORS, LANGENBECK	82	W. BARRY ROOTS ELEVATOR	25
MINI PIN & LIGATURE CUTTER TC	106	RETRACTORS, MINI-LANGENBECK	81	URINAL FEMALE, URINAL MALE, URINAL MALE VERTICAL	150
MIXING SPATULA WITH SHOVEL	124	RETRACTORS, UNIQUE	81	WAHL BONE FILES	94
MODIED MCCALL	60	RETRO FILLING	81	WALDSAVHS WIRE BENDING AND CUTTING PLIERS	101
MOLT BONE FILES	94	REVERSED LIGATURE CUTTER ANGLED	102	WALL FILLING INSTRUMENTS	79
MOLT PERIOSTEAL ELEVATORS	95	RHODIUM MIRRORS	30	WANGEN HOLDER	68
MORTONSEN FILLING INSTRUMENT	55	ROCHESTER-KOCHER 1X2 HAEMOSTATIC FORCEPS	87	WARD AMALGAM CARVERS	56
MOUTH GAG MOLT	78	ROCHESTER-PEAN HAEMOSTATIC FORCEPS	87	WARD FILLING INSTRUMENTS	69
MOUTH MIRROR	37	ROOT ELEVATOR	15-29	WAX KNIVES	76
MSY CEMENT SPATULAS	75	ROOT PLANNING FILES	94	WEDEL-STAEHT	71
MULTIFUNCTIONAL METER	108	ROOT PLANNING FILES & BONE FILES	94	WEINGART GENERAL UTILITY PLIER LONG MOUTH WITH TC	103
MISCELLANEOUS PRODUCTS	740	ROOTS ELEVATOR	22	WEINGART PLIER MEDIUM	99-101
NAKAWALN. DENTAL LABORATORY INSTRUMENTS	77	ROSER-KONIG CHEEK RETRACTORS	79		





DESCRIPTION	PAGE #	DESCRIPTION	PAGE #	DESCRIPTION	PAGE #
WEINGART PLIER REGULAR WITH TC	103				
WEINGART PLIER SLIM WITH TC	102				
WEINGART PLIER UNIVERSAL WITH TC	103				
WEINGART PLIER UTILITY WITH TC	103				
WEITLANDER CHEEK RETRACTORS	79				
WEITLANDER CHEEK RETRACTORS	79				
WERDELSTAEDT FILLING INSTRUMENTS	74				
WESTON CEMENT SPATULAS	75				
WIDE MATRIX RETAINERS	91				
WILLIAM PROBE SET	38				
WILLIAMS EXPLORERS	36				
WINGURT PLIER SLIM	105				
WINGURT UTILITY PLIER	105				
WINTER ROOTS ELEVATOR	25				
WIRE BENDING & LOOP FORMING PLIERS	99				
WISDOM ROOTS ELEVATOR	21				
WOODEN HANDLE	76				
WOODSON FILLING INSTRUMENTS	49				
YOUNG PLIER WITH GROOVED	105				
YOUNG TONGUE FORCEPS	99				
YOUNG WIRE BENDING & LOOP FORMING PLIERS	99				
ZAHLE CEMENT SPATULAS	75				





LUMINES INTERNATIONAL

Manufacturers & Exporters of Dental Instruments.

Pakistan Office:

Nasir Road, Sialkot - Pakistan

Tel: +92-52-3258083

Mobile/whatsapp: +92-333-8637260

E-mail: info@luminesintl.com

web: www.luminesintl.com

Korea Office

249 Igwang Myeon Gijang Gng

Busan .korea

Mobile No :010 2583 6667

korealumines@gmail.com



ISO:13485
2015-1

